

Original Instructions



BeamMonitor BM+

BM+ 60, BM+ 100S

LaserDiagnosticsSoftware LDS

IMPORTANT!

READ CAREFULLY BEFORE USE.

KEEP FOR FUTURE USE.

Table of contents

1	Basic safety notes	7
2	Symbols and conventions	8
3	About this operating manual	9
4	Device description	10
4.1	Device type overview.....	10
4.2	Functional description	10
4.3	Measuring principle	10
4.4	Optical displays.....	11
4.5	Explanation of the product safety labels	11
4.5.1	Warning of hand injuries.....	11
4.5.2	Observe beam path	12
4.6	Scope of delivery and accessories	12
5	Quick overview installation	13
6	Transport and storage	13
7	Mounting	14
7.1	Conditions at the installation site	14
7.2	Installation in the laser system	14
7.2.1	Prepare mounting	14
7.2.2	Possible mounting positions.....	14
7.2.3	Align the device.....	15
7.2.4	Mount the device	15
7.3	Deinstallation of the device.....	18
8	Connections	18
8.1	Overview of the connections	18
8.1.1	Connections of the BeamMonitor BM+ 60	18
8.1.2	Connections of the BeamMonitor BM+ 100S.....	18
8.2	Power supply (Power In).....	19
8.3	Ethernet.....	20
8.4	PRIMES bus RS485.....	20
8.5	Connection of the BeamMonitor BM+ and PowerMonitor PM 48/100 to the PC	21
9	Measuring with the LaserDiagnosticsSoftware LDS	22
9.1	Warning messages.....	22
9.2	Connecting / disconnecting the device with the LaserDiagnosticsSoftware LDS.....	24
9.2.1	Switch on the device and connect it to the LDS.....	24
9.2.2	If the device does not appear in the connections window	25
9.2.3	Change the network address of a connected device.....	26
9.2.4	Disconnect and switch off the device	26
9.3	General information about working with the LDS.....	27
9.3.1	Open „Device control“ menu	27
9.3.2	Open a measuring mode	27
9.3.3	Enter parameters and activate	28
9.3.4	Move axes	29
9.3.5	Saving options	30
9.3.6	Considering the messages in the LaserDiagnosticsSoftware LDS during measurement.....	31

9.4	Single planes.....	32
9.4.1	Settings	32
9.4.2	Advanced settings	35
9.4.3	Search laser beam automatically with the find beam function.....	37
9.4.4	Adjust the size and position of the measurement window manually.....	38
9.4.5	Start measurement	39
9.4.6	Manual caustic measure	39
9.4.7	Display of the measurement results.....	41
9.5	Monitor	42
9.5.1	Settings	42
9.5.2	Advanced settings	44
9.5.3	Search laser beam automatically with the find beam function.....	45
9.5.4	Adjust the size and position of the measurement window manually.....	46
9.5.5	Start measurement	47
9.5.6	Display of the measurement results.....	48
9.6	Linescan	49
9.6.1	Settings	49
9.6.2	Advanced settings	51
9.6.3	Search laser beam automatically with the find beam function.....	52
9.6.4	Adjust the width (length) and position of the measuring line manually.....	53
9.6.5	Start measurement	54
9.6.6	Display of the measurement results.....	55
10	Troubleshooting	56
11	Maintenance and service	57
11.1	Maintenance intervals.....	57
11.2	Cleaning the device surfaces.....	57
12	Measures for the product disposal	58
13	Declaration of conformity	59
14	Technical data	60
15	Dimensions	62
15.1	BeamMonitor BM+ 60.....	62
15.2	BeamMonitor BM+ 100S	63
16	Appendix	64
16.1	GNU GPL license notice.....	64
16.2	Variety of detectors	64
16.3	Replace the detector.....	65
16.3.1	Remove cover.....	65
16.3.2	Disassemble the detector	65
16.3.3	Assemble the detector.....	67
16.3.4	Replace cover.....	67

PRIMES - The Company

PRIMES manufactures measuring devices used to analyze laser beams. These devices are employed for the diagnostics of high-power lasers ranging from CO₂ lasers and solid-state lasers to diode lasers. A wavelength range from IR through to near UV is covered, offering a wide variety of measuring devices to determine the following beam parameters:

- Laser power
- Beam dimensions and position of an unfocused beam
- Beam dimensions and position of a focused beam
- Beam quality factor M^2

PRIMES is responsible for both the development, production, and calibration of the measuring devices. This guarantees optimum quality, excellent service, and a short reaction time, providing the basis for us to meet all of our customers' requirements quickly and reliably.



PRIMES GmbH
Max-Planck-Str. 2
64319 Pfungstadt
Germany

Tel +49 6157 9878-0
info@primes.de
www.primes.de

1 Basic safety notes

Intended use

The device has been designed exclusively for measurements of high-power lasers.

Use for any other purpose is considered as not intended and is strictly prohibited. Furthermore, intended use requires that you observe all information, instructions, safety notes and warning messages in this operating manual. The specifications given in chapter 14 „Technical data“ on page 60 apply. Any given limit values must be complied with.

If not used as intended, the device or the system in which the device is installed can be damaged or destroyed. In addition, there is an increased risk to health and life. Only use the device in such a way that there is no risk of injury.

This operating manual is an integral part of the device and must be kept in the immediate vicinity of the place of use, accessible to personnel at all times.

Every person who is responsible for the installation, start-up or operation of the device must have read and understood the operating manual and, in particular, the safety instructions.

If you still have questions after reading this operating manual, please contact PRIMES or your supplier for your own safety.

Observing applicable safety regulations

Observe the safety-relevant laws, guidelines, standards and regulations in the current editions published by the state, standardization organizations, professional associations, etc. In particular, observe the regulations on laser safety and comply with their requirements.

Necessary safety measures



DANGER

Serious eye or skin injury due to laser radiation

The device measures direct laser radiation, but does not emit any radiation itself. However, during the measurement the laser beam is reflected at the rotating measuring tip. This produces scattered or directed reflection of the laser beam (laser class 4). The reflected beam is usually not visible.

- ▶ In measurement mode, a safety distance of one meter to the device must be maintained even when wearing safety goggles and safety clothing.
- ▶ Protect yourself from direct and reflected laser radiation while working with the device by taking the following measures:

- Never leave the device unattended when taking measurements.
- If the device is moved from its aligned position, increased scattered or directed reflection of the laser beam occurs during measuring operation. Mount the device in such a way that it cannot be moved by unintentional bumping or pulling on the cables.
- Install safety switches or emergency safety mechanisms that allow the laser to be switched off immediately.
- Use suitable beam guidance and beam absorber elements which do not emit any hazardous substances when irradiated.
- Wear **safety goggles OD 6** adapted to the power, power density, laser wavelength and operating mode of the laser beam source in use.
- Wear suitable **protective clothing** or **protective gloves** if necessary.
- If possible, also protect yourself from direct laser radiation and scattered radiation by using separating protective devices that block or attenuate the radiation.

Employing qualified personnel

The device may only be operated by qualified personnel. The qualified personnel must have been instructed in the installation and operation of the device and must have a basic understanding of working with high-power lasers, beam guiding systems and focusing units.

Conversions and modifications

The device may not be modified in terms of design or safety without the explicit consent of the manufacturer. The same applies to unauthorized opening, dismantling and repair. The removal of covers is only permitted within the scope of the intended use.

Liability disclaimer

Manufacturer and distributor exclude any liability for damages and injuries which are direct or indirect consequences of using the device not as intended or modifying the device or the associated software without authorization.

2 Symbols and conventions

Warning messages

The following symbols and signal words indicate possible residual risks in the form of warnings:

**DANGER**

Means that death or serious physical injuries **will** occur if necessary safety precautions are not taken.

**WARNING**

Means that death or serious physical injuries **may** occur if necessary safety precautions are not taken.

**CAUTION**

Means that minor physical injury **may** occur if necessary safety precautions are not taken.

NOTICE

Means that property damage **may** occur if necessary safety precautions are not taken.

Product safety labels

The following symbols are used on the device itself to indicate imperatives and possible dangers:



Read and observe the operating instructions and safety guidelines before startup!



Hand injuries warning



General warning sign

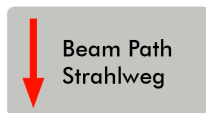

Observe beam path

Further symbols and conventions in this operating manual



Here you can find useful information and helpful tips.

- ▶ Indicates a simple instruction.
If several such instructions appear one below the other, then the order of their execution is irrelevant or they are alternative procedures.
- 1. A numbered list identifies a sequence of instructions that must be executed in the specified order.
- 2.
- ...
- ➔ Indicates the result of an action to explain processes that take place in the background.
- 👁 Indicates an observation prompt to draw attention to visible feedback from the device or the software.
Observation prompts make it easier to check whether an instruction was executed successfully. Often they also guide to the next instruction.
- 👆 Points to a control element that is to be pressed / clicked.
- ➔ Points to an element described in the text (for example an input field).

3 About this operating manual

This manual describes the installation and operation of the BeamMonitor BM+ and how to perform measurements with the LaserDiagnosticsSoftware LDS.

For measurement operation with a PC, the LaserDiagnosticsSoftware LDS must be installed on the PC. The LDS is included in the scope of delivery.

The software description includes a brief introduction on using the device for measurements.

For a detailed description of the software installation, file management and evaluation of the measurement data, please refer to the separate instructions for the LaserDiagnosticsSoftware LDS.



This operating manual describes the software version valid at the time of printing. Since the user software is continuously being developed further, the supplied data medium may have a higher version number.

If you have questions, please let us know the software version you are using. The software version can be found under the following menu item: **Help > About LaserDiagnosticsSoftware**.

4 Device description

4.1 Device type overview

There are two types of the BeamMonitor BM+.

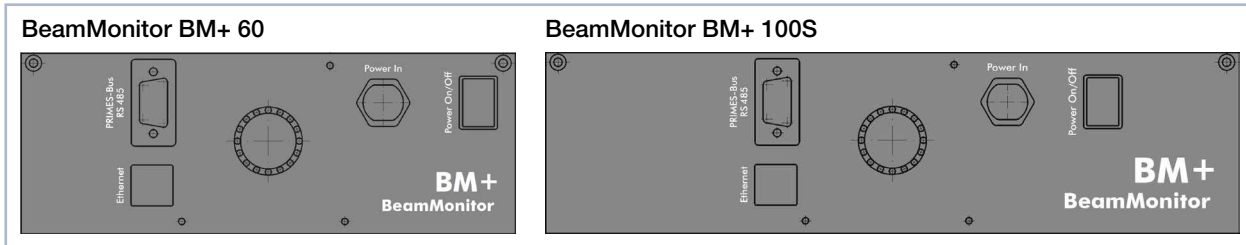

Fig. 4.1: Device types BM+ 60 and BM+ 100S

4.2 Functional description

The BeamMonitor BM+ is an opto-mechanically measuring system that scans the laser beam with a special measuring tip. This is equipped with a small pinhole or reflecting mirror that collects a small section of the laser beam. Another reflecting mirror guides this portion of the laser light to a detector selected and configured depending on the used wavelength.

4.3 Measuring principle

By moving the rotating disk orthogonal to the propagation direction of the laser beam, a power density distribution is recorded. The high orbital velocity of the rotating measuring tip facilitates analysis of high power densities. A very high signal-to-noise ratio is achieved thanks to the dynamics of the analog-digital converter used. Very low intensities are shown with equal precision next to the high peak intensities.

Using the LaserDiagnosticsSoftware LDS, the BM+ can be set to automatically repeat the measurements at a predefined interval. To verify the beam profile or position changes over a longer period of time, an unlimited number of measurements can be entered. For the consideration of shorter time intervals the established Linescan can be used up to a frequency of 25 Hz.

A newly developed algorithm enables the automatic detection and analysis of rectangular laser beams. Besides the lateral length, many parameters like the azimuth angle, flank steepness, flatness and uniformity are precisely calculated.

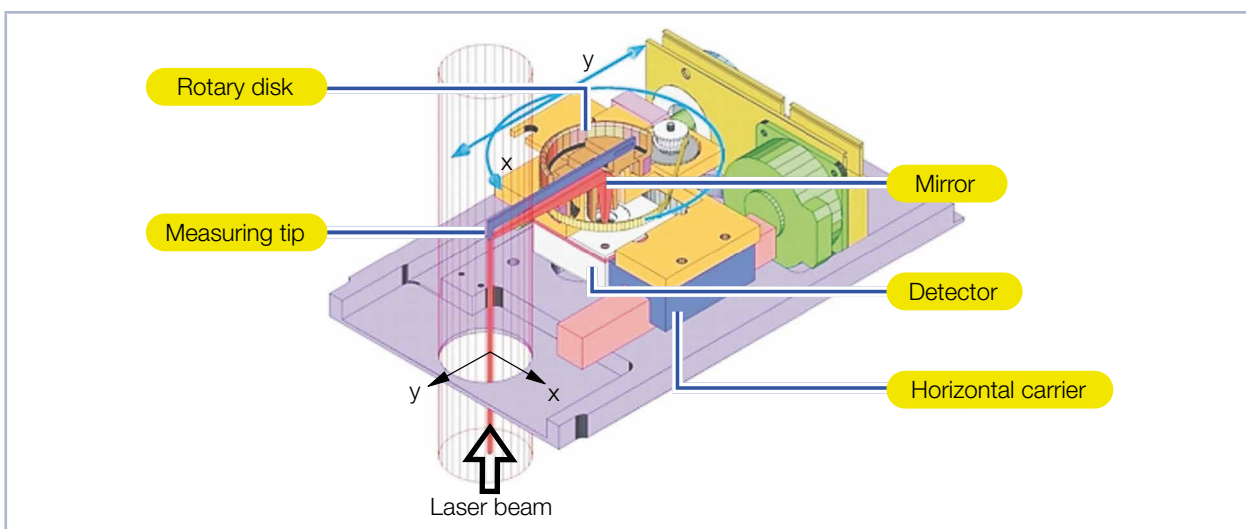
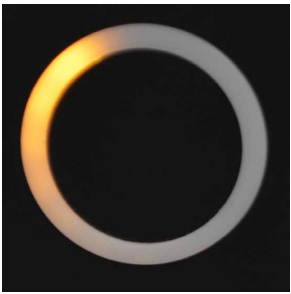

Fig. 4.2: Optomechanical design of the BeamMonitor BM+

4.4 Optical displays

The status display consists of a light ring that indicates different states of the BeamMonitor BM+ with different colors and static or rotating lights.

	Color	Lighting state	Meaning
	White	The entire ring illuminates	The supply voltage is connected
	Yellow	Rotating light	The measuring tip rotates.
	Red	Rotating light	The measuring tip rotates and the y-axis is moved. The measurement is in progress.

Tab. 4.1: States of the status display

4.5 Explanation of the product safety labels

4.5.1 Warning of hand injuries

A potential hazard area for hand injuries and device damage is marked with a symbol on the device.

The measuring tip of the BeamMonitor BM+ rotates at high speed during the measuring operation. Even after the measurement or switching off the device, the measuring tip will continue to rotate for a certain amount of time. To avoid hand injury, do not reach into the aperture of the device.

If the rotating measuring tip hits an obstacle, the measuring tip is de-adjusted. In this case, the device must be sent in for service. Therefore, no objects may get into the aperture.

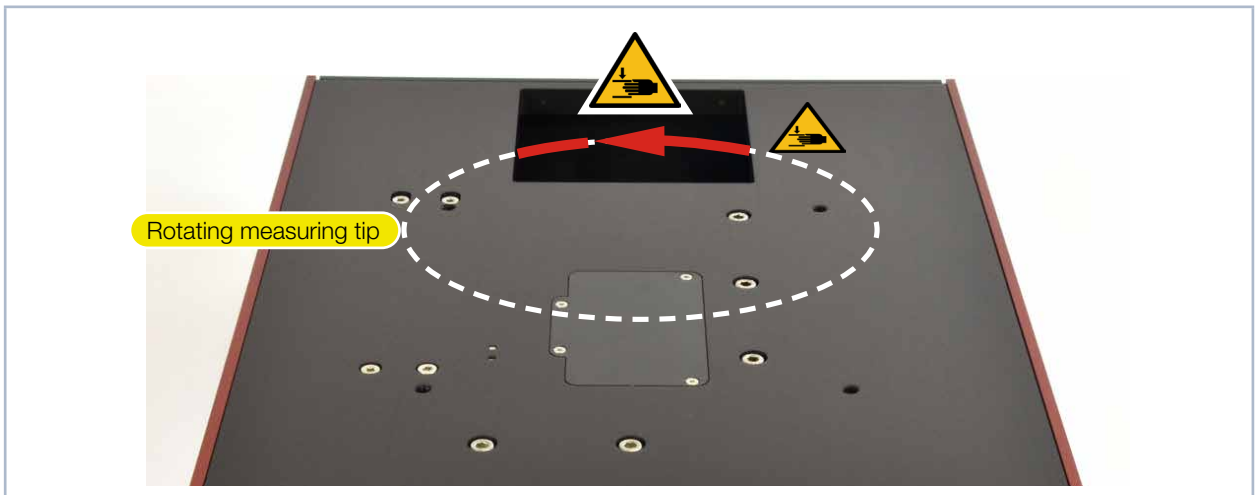

Fig. 4.3: Danger caused by the rotating measuring tip using the BM+ 100S as an example

4.5.2 Observe beam path

The BeamMonitor BM+ can be mounted in any installation position. The direction of the laser beam through the device must be observed. The beam path is indicated on the device.



Fig. 4.4: Beam path using the BM+ 60 as an example

4.6 Scope of delivery and accessories

The following parts are included in the scope of delivery of the BeamMonitor BM+:

- BeamMonitor BM+
- PRIMES power supply
- Power cable

- Patch cable Cat.5e, 5 m, Cross-Over
- Patch cable Cat.5e, 5 m
- USB stick (PDF of operating instructions, software, etc.)

- Operating manual BeamMonitor BM+
- Operating manual LaserDiagnosticsSoftware LDS

The following accessories are available for the BeamMonitor BM+:

- Transport and storage case

5 Quick overview installation

<ol style="list-style-type: none"> 1. Installing the LaserDiagnosticsSoftware LDS on the PC <ul style="list-style-type: none"> • The software is included in the scope of delivery. 	See separate Operating Manual of the LaserDiagnosticsSoftware LDS
<ol style="list-style-type: none"> 2. Taking safety precautions 	Chapter 1 on page 7
<ol style="list-style-type: none"> 3. Prepare mounting <ul style="list-style-type: none"> • Observe warning messages • Set mounting position • Mounting the device stably 	Chapter 7 on page 14
<ol style="list-style-type: none"> 4. Establish connections <ul style="list-style-type: none"> • Power supply Power In • Ethernet • PRIMES-Bus (RS485) • Parallel operation of the BeamMonitor BM+ for example with the laser power meter PowerMonitor PM 48/100 	Chapter 8 on page 18
<ol style="list-style-type: none"> 5. Measure <ul style="list-style-type: none"> • Observe warning messages • Connect device to the LDS • Perform measurements 	Chapter 9 on page 22

6 Transport and storage

NOTICE

Damage / Destruction of the device

Optical components may be damaged if the device is subjected to hard shocks or is allowed to fall.

- ▶ Handle the device carefully when transporting or installing it.

7 Mounting

7.1 Conditions at the installation site

- The device must not be operated in a condensing atmosphere.
- The ambient air must be free of organic gases.
- Protect the device from splashes of water and dust.
- Operate the device in closed rooms only.

7.2 Installation in the laser system

7.2.1 Prepare mounting

Check the available space before installing the device, especially the required space for the connection cables. The device must be positioned in a stable position and secured with screws (see chapter 7.2.4 on page 15).



Fire and explosion hazards due to scattered or directed laser radiation

When the BeamMonitor BM+ is being operated, the irradiation must be fully absorbed behind the measurement zone. Fire bricks or other partly-absorbing surfaces are not suitable.

- ▶ Use an adequate absorber. Dependent on the application, PRIMES offers suitable laser power meters, such as the PowerMonitor PM 48/100.

7.2.2 Possible mounting positions

The BeamMonitor BM+ can be mounted horizontally or vertically.

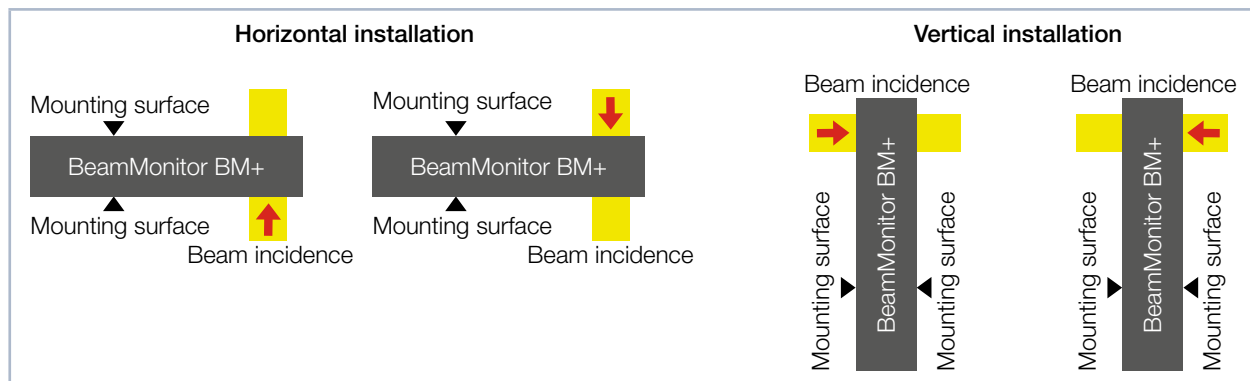

Fig. 7.1: Possible mounting positions of the device

7.2.3 Align the device

For the BeamMonitor BM+, a perpendicular beam incidence with respect to the x-y plane must be ensured. The laser beam should hit the centre of the entrance aperture.



DANGER

Serious eye or skin injury due to laser radiation

If the ratio of the laser beam diameter to the entrance aperture is too large, increased scattered or directed reflection of the laser beam (laser class 4) will occur during measuring operation. The housing of the BeamMonitor BM+ can heat up.

- ▶ According to the definition of the 86 % power inclusion, the laser beam diameter must not exceed 0.7 times the entrance aperture.
- ▶ Especially in case of laser with high beam quality, the laser beam diameter must not exceed 0.6 times the entrance aperture. Otherwise, a falsification of the measuring results due to the cutting off of border fields is to be expected.
This can lead to measurement errors, especially when determining the radius using the second moment method.

7.2.4 Mount the device



DANGER

Serious eye or skin injury due to laser radiation

If the device is moved from its calibrated position, increased scattered or directed reflection of the laser beam occurs during measuring operation (laser class 4).

- ▶ Mount the device in a way that it cannot be moved by an unintentional knock or cables being pulled accidentally.

NOTICE

Damage / Destruction of the device

Fastening screws that are too long can damage internal components of the device.

- ▶ The fastening screws must not be screwed in more than 10 mm into the housing.

There are four threaded holes M6 in the mounting surface of the housing for assembly on a support bracket provided by the customer (see Fig. 7.2 on page 16 and Fig. 7.3 on page 17).

Please use at least four screws M6 to fasten the device. The total length of the screws depends on the dimensions of the customer's support bracket.

Mount the BeamMonitor BM+ 60

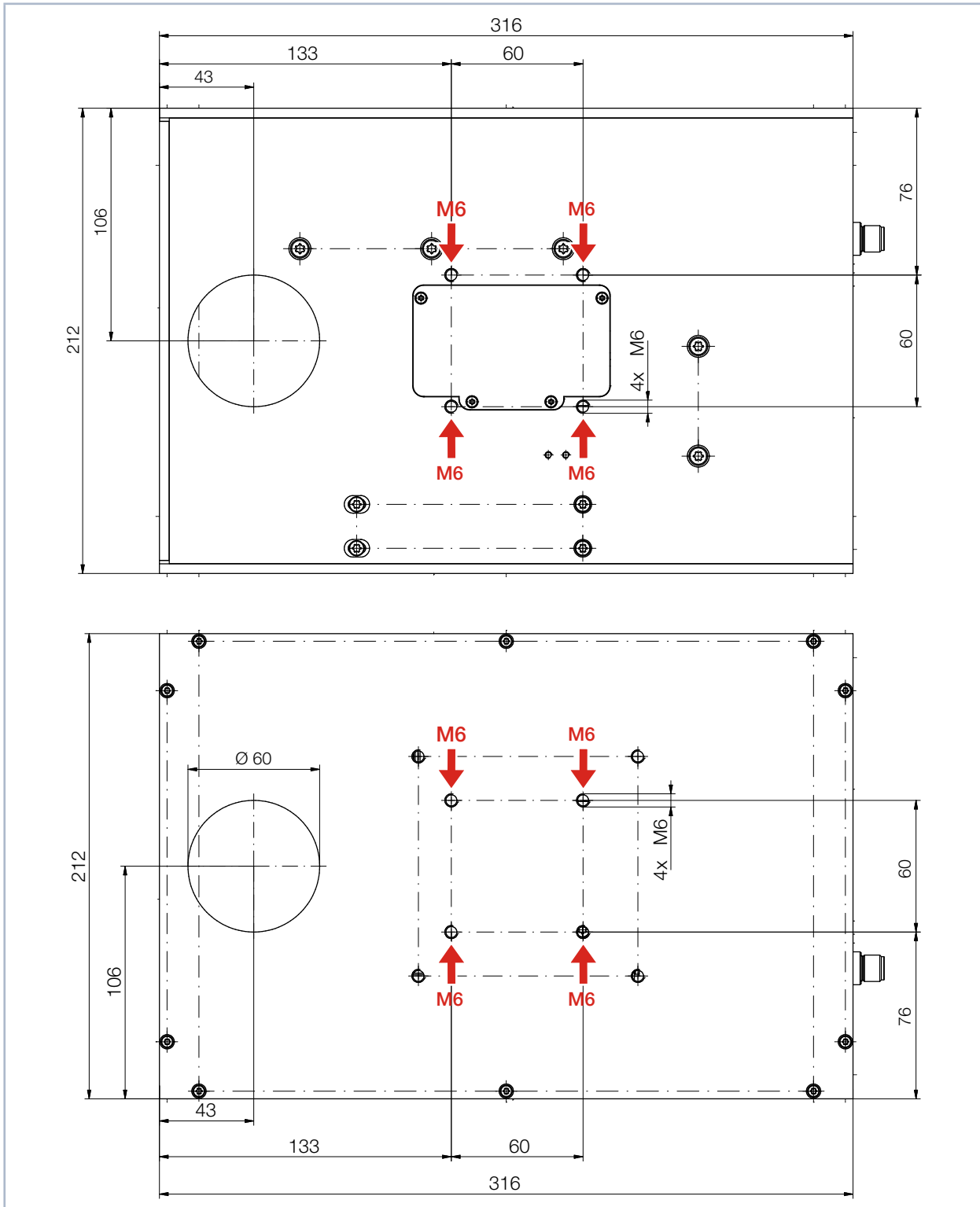

Fig. 7.2: Threaded holes on the BeamMonitor BM+ 60 top and bottom view

Mount the BeamMonitor BM+ 100S

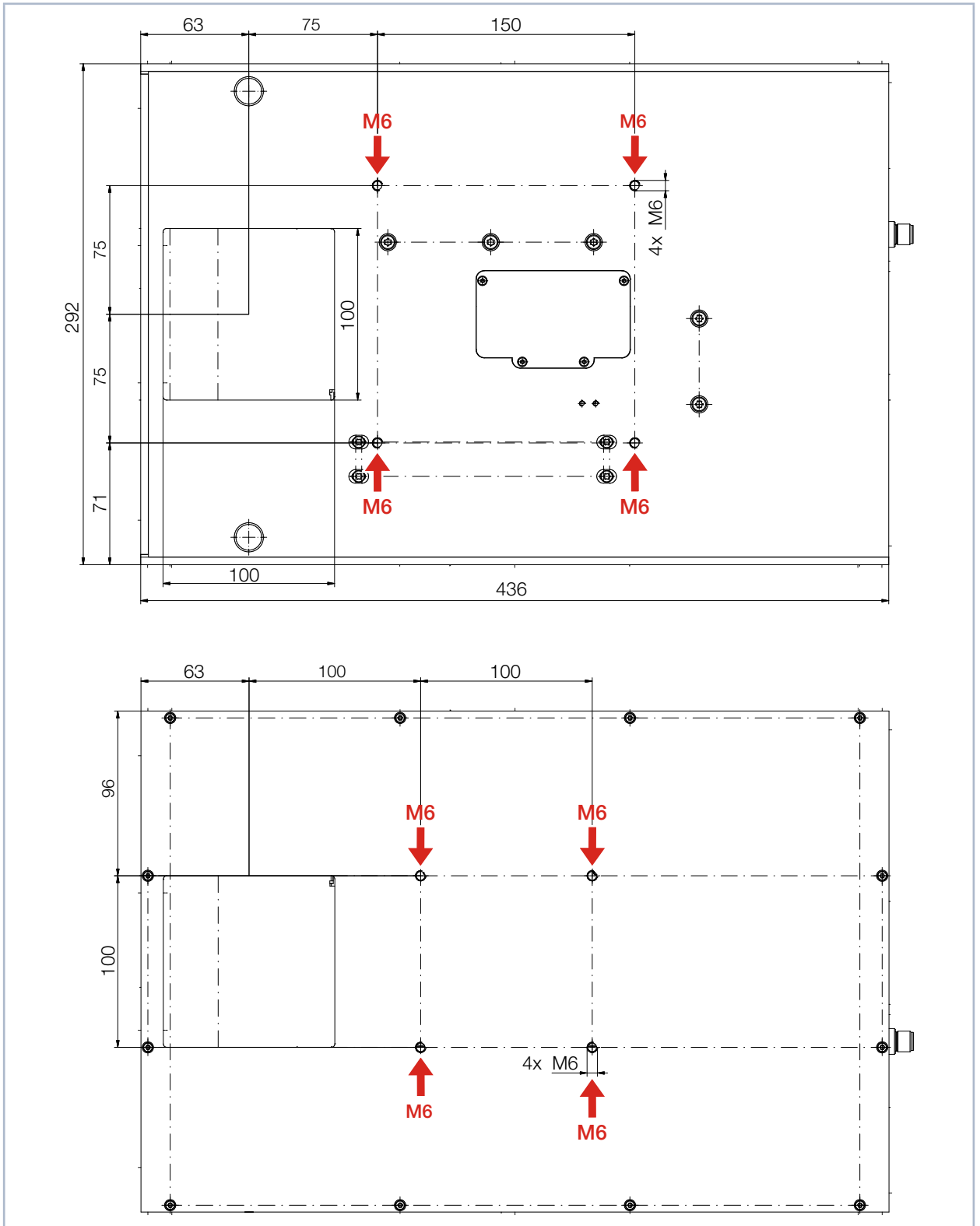

Fig. 7.3: Threaded holes on the BeamMonitor BM+ 100S top and bottom view

7.3 Deinstallation of the device

1. Turn off the laser source.
2. Ensure that moving parts, e.g. robot arms, etc. are at a standstill and cannot be set in motion unintentionally.
3. Switch off the BM+ at the Power On / Off switch.
4. Unscrew the fixing screws from the threaded holes.
5. Disconnect the cables and remove the device from the laser system.

8 Connections

Please only use the PRIMES power supply unit and the provided connection cables.

Please establish all electrical connections and switch on the device before starting the LaserDiagnosticsSoftware LDS.

8.1 Overview of the connections

8.1.1 Connections of the BeamMonitor BM+ 60

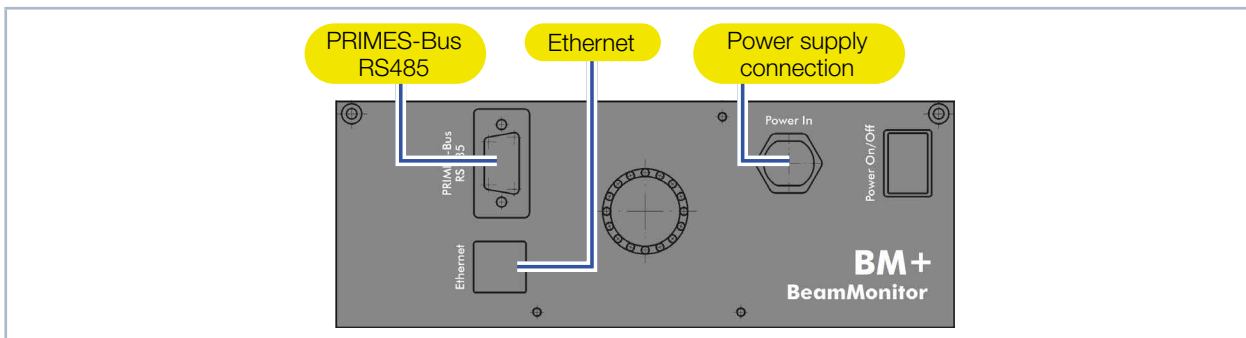

Fig. 8.1: Connections of the BeamMonitor BM+ 60

8.1.2 Connections of the BeamMonitor BM+ 100S

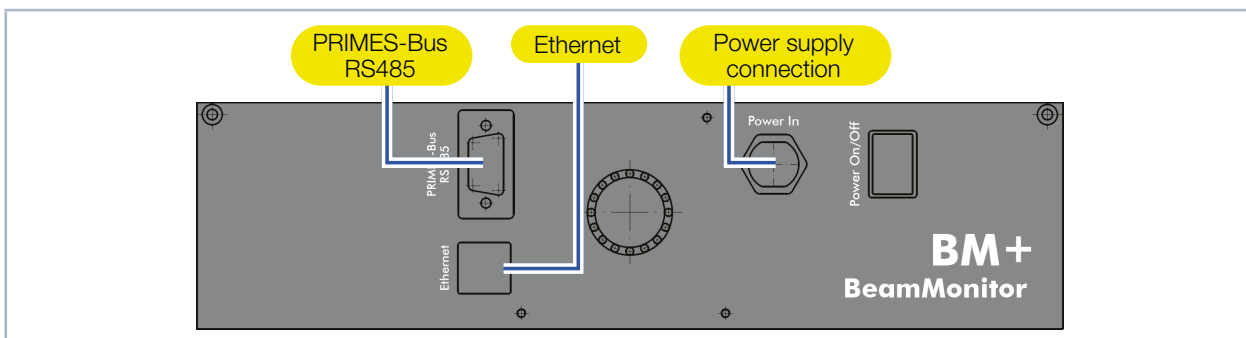

Fig. 8.2: Connections of the BeamMonitor BM+ 100S

8.2 Power supply (Power In)

The BeamMonitor BM+ requires a voltage supply of $24\text{ V} \pm 5\%$ (DC) for the operation. A suitable power supply is included in the scope of delivery.

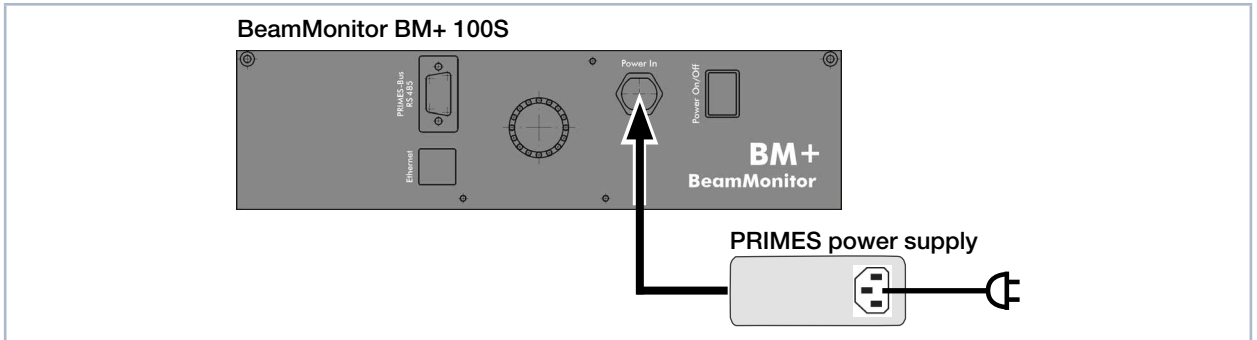
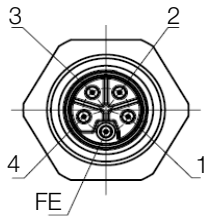

Fig. 8.3: Connection of the power supply using the BM+ 100S as an example

Harting M12-P-PCB-THR-2PC-5P-LCOD-M-STR	
Pin	Function
1	+24 V
2	Not assigned
3	GND
4	Not assigned
5	FE (functional earth)



Tab. 8.1: Pin assignment of the connection socket for the PRIMES power supply

8.3 Ethernet

Data is transmitted between the BeamMonitor BM+ and PC via the Ethernet connection.

Connect the BeamMonitor BM+ to the PC via a crossover cable or to the network via a patch cable.

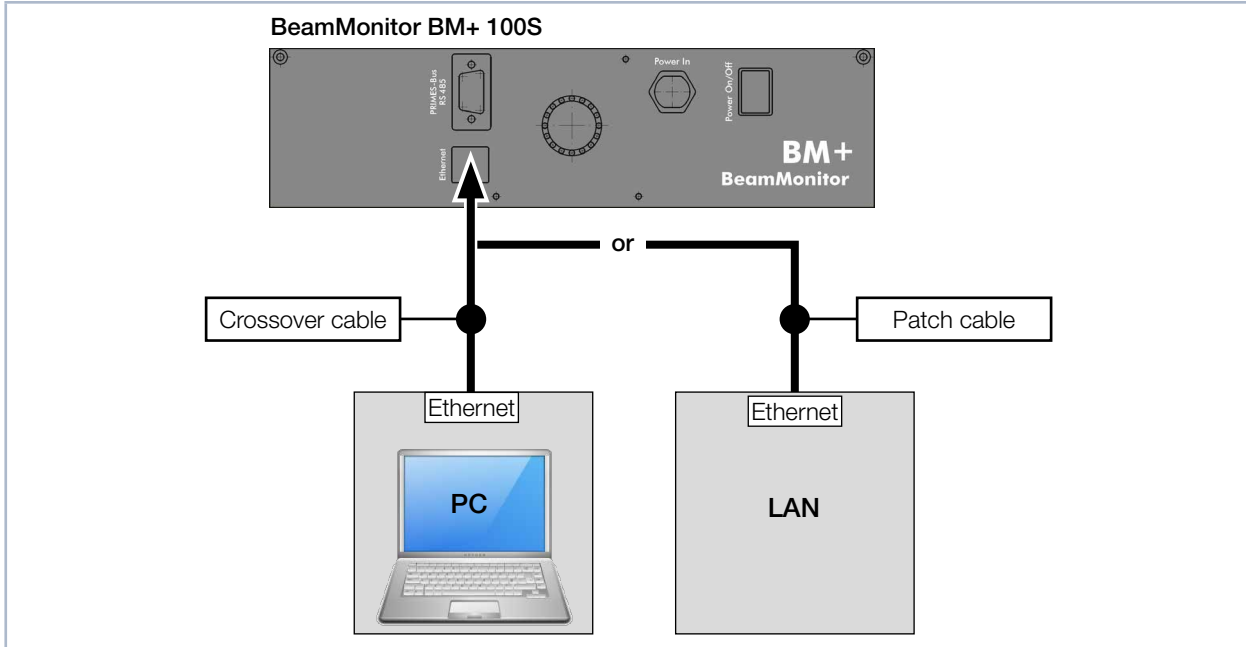

Fig. 8.4: Ethernet connection using the BM+ 100S as an example

8.4 PRIMES bus RS485

Another device, such as a PowerMonitor PM 48/100, can be connected to the BeamMonitor BM+ via the RS485 interface (PRIMES bus).

The signal from the PM 48/100 is transmitted through the BM+ to the PC via the Ethernet interface. The additional measuring device is powered by the power supply of the BM+.

Pin assignment D-sub socket, 9-pin (view of plug-in side)	
Pin	Function
1	GND
2	RS485 (+)
3	+24 V
4	Not assigned
5	Not assigned
6	GND
7	RS485 (-)
8	+24 V
9	Not assigned

Tab. 8.2: Pin assignment of the D-Sub socket, PRIMES bus

8.5 Connection of the BeamMonitor BM+ and PowerMonitor PM 48/100 to the PC

For sufficient absorption of the radiation behind the measurement zone, you can use the PRIMES laser power meter PM 48/100. The water-cooled PM 48/100 will measure the current laser power and provide additional information on the flow rate and temperature of the cooling water.

NOTICE

Damage / Destruction of the device due to overvoltage

When disconnecting the electrical lines during operation (with the supply voltage applied), voltage peaks occur which can destroy the communication modules of the devices.

- ▶ Disconnect the supply voltage from the device before disconnecting the bus cables.



When connecting several devices, always use only one PRIMES power supply unit for the voltage supply.

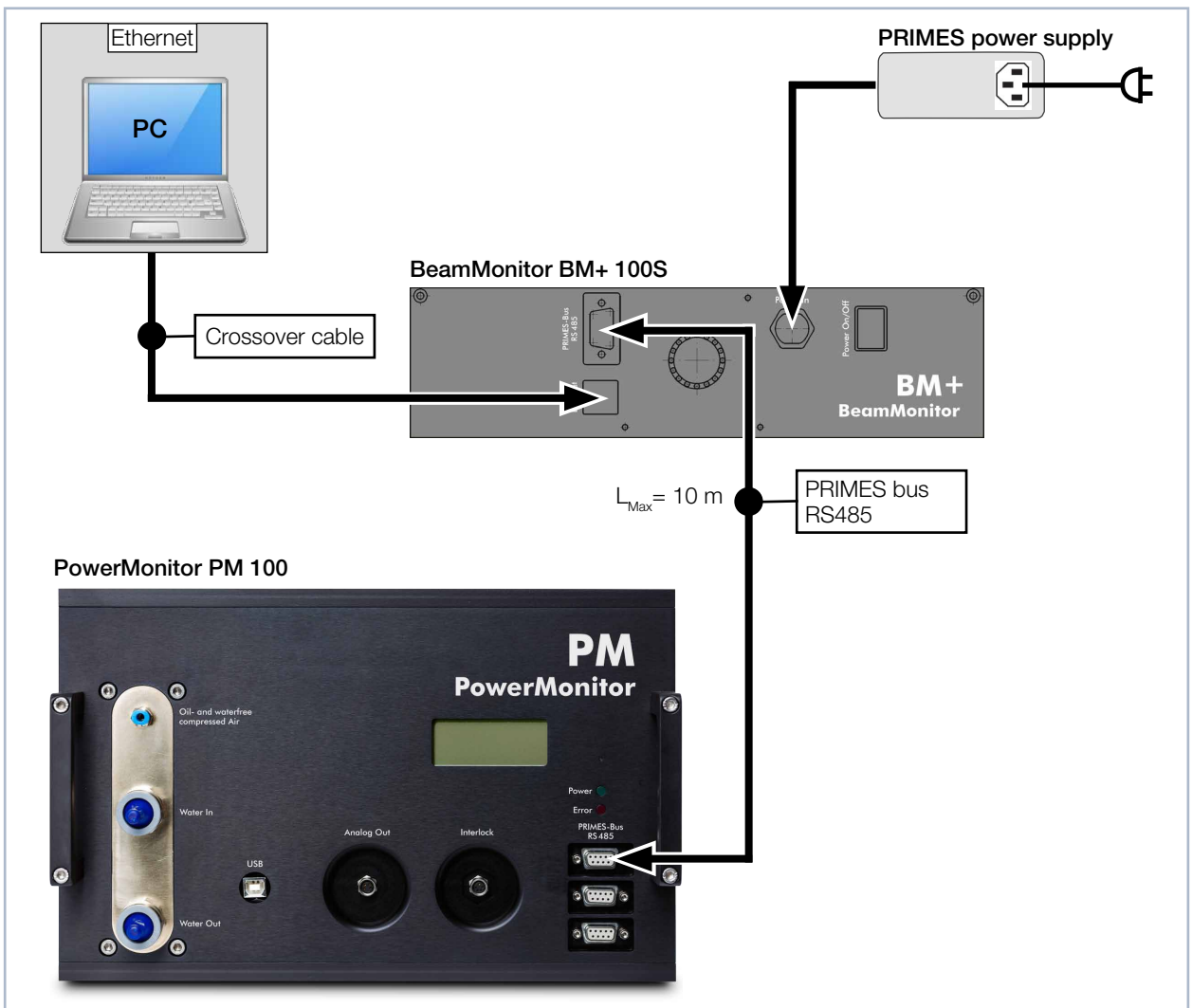

Fig. 8.5: Connection to the PC using the example of the BM+ 100S together with the PowerMonitor PM 100

9 Measuring with the LaserDiagnosticsSoftware LDS

This chapter describes measurements with the LDS. For a detailed description of the software installation, file management and evaluation of the measured data, please refer to the separate operating manual LDS.

9.1 Warning messages



DANGER

Serious eye or skin injury due to laser radiation

The device measures direct laser radiation, but does not emit any radiation itself. However, during the measurement the laser beam is reflected at the rotating measuring tip. This produces scattered or directed reflection of the laser beam (laser class 4). The reflected beam is usually not visible.

- ▶ Please wear safety goggles OD 6 adapted to the power, power density, laser wave length and operating mode of the laser beam source in use.
- ▶ Wear suitable protective clothing and protective gloves.
- ▶ Protect yourself from laser radiation by separating protective devices (e.g. by using appropriate shielding).
- ▶ In measurement mode, a safety distance of one meter to the BeamMonitor BM+ must be maintained even when wearing safety goggles and safety clothing.



DANGER

Serious eye or skin injury due to laser radiation

If the device is moved from its aligned position, increased scattered or directed reflection of the laser beam occurs during measuring operation (laser class 4).

- ▶ Mount the device so that it cannot be moved by an unintentional knock or cables being pulled accidentally.



DANGER

Fire and explosion hazards due to scattered or directed laser radiation

When the BeamMonitor BM+ is being operated, the irradiation must be fully absorbed behind the measurement zone. Fire bricks or other partly-absorbing surfaces are not suitable.

- ▶ Use an adequate absorber. Dependent on the application, PRIMES offers suitable laser power meters, such as the PowerMonitor PM 48/100.

**CAUTION****Risk of injury caused by rotating parts**

The measuring tip of the BeamMonitor BM+ rotates at high speed during the measuring operation. Even after the measurement or switching off the device, the measuring tip will continue to rotate for a certain amount of time.

If the rotating measuring tip hits an obstacle, the device must be sent in for service to readjust the measuring tip.

- ▶ Do not reach into or hold any objects into the beam entrance of the device (see Fig. 4.3 on page 11).
- ▶ After the rotation of the device has been turned off, wait until the measuring tip comes to a complete stop (pay attention to the status display on the connection side).

9.2 Connecting / disconnecting the device with the LaserDiagnosticsSoftware LDS

The PRIMES device obtains an IP address from the network via the Ethernet connection. The PC used must be in the same IP address range as the PRIMES device. The DHCP option is deactivated by default (see chapter 9.2.3 on page 26).

9.2.1 Switch on the device and connect it to the LDS

1. Switch on the device at the Power On / Off switch.
 👁 The optical display (see chapter 4.4 on page 11) shows the operating status.
2. Start the LDS by double-clicking on the program icon **LDS** in the start menu group or on the desktop icon.

👁 The start screen appears.

3. Select the operating mode **Measure**.

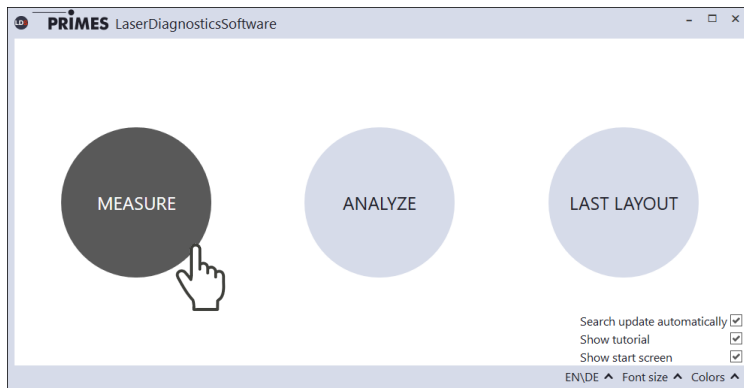

Only if the Show start screen option is disabled:

- ▶ Click on the **Devices** tab and then on the **+ Connect to device** button.

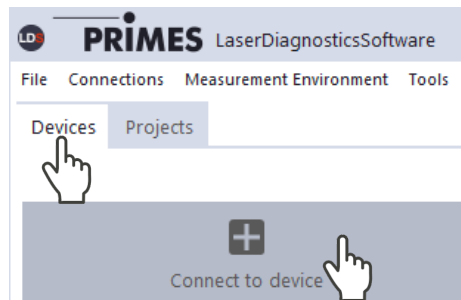

👁 The **Connections** window appears.

4. Click on the desired device.
5. Click on the **Connect to device** button.

If the device does not appear:

1. Click on the **Search the network** button.
2. If the device still does not appear in the **Connections** window, see chapter 9.2.2 on page 25

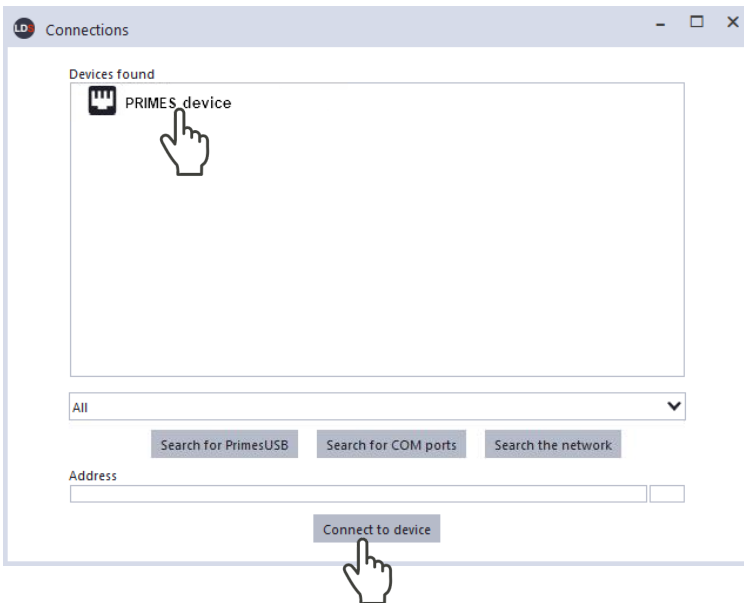

9.2.2 If the device does not appear in the connections window

The connection of the device to the LaserDiagnosticsSoftware LDS may be blocked by the firewall:

- ▶ In **Windows > Control panel > Firewall**, enable the UDP port 20034.

The UDP port should be enabled by a system administrator.

The network address of the PC is not within the range of the device.

- ▶ **In Windows > Control panel > Network and Sharing Center**, assign an IP address to your PC that is in the same address range as the PRIMES device (e.g. 192.168.116.xyz). The IP address of your PRIMES device can be found on the identification plate.

The IP address should be entered by a system administrator.

If several network cards or a USB3-to-Ethernet card are installed in the PC, the connection between device and LaserDiagnosticsSoftware LDS may be blocked by the selection of the wrong network card.

1. Select the appropriate network card in the **Connections > All** window.

👁 The device is displayed in the **Connections** window

2. Click on the device.
3. Click on the **Connect to device** button.

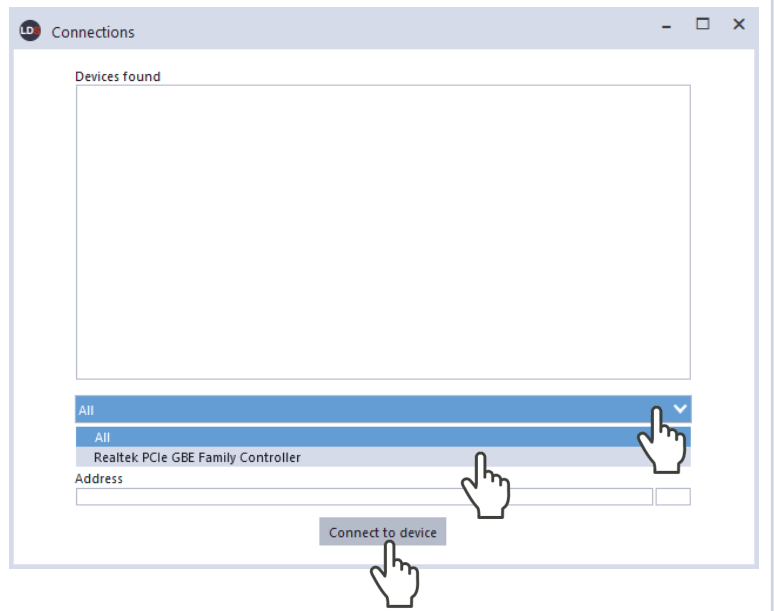

9.2.3 Change the network address of a connected device

For communication in a network, a **Static IP address** is stored for the device in the LDS and the function **Use DHCP** is activated. When establishing a connection, the device will first wait to be assigned a suitable IP address via DHCP. If this proves unsuccessful, it will revert to the static IP address.

If **Use DHCP** is disabled, the device will directly use the static IP address. As a result, the connection can be established faster.

For a connected device, both the IP address and the activation of DHCP can be changed.

Change the IP address of a device as follows:

1. Click on the **Devices** tab.
2. Right-click on the device and select the **Device settings** menu point.
3. Enter the desired IP address or use the **Use DHCP** function
4. Confirm the entry with **OK**.
5. Switch the device off and on again.

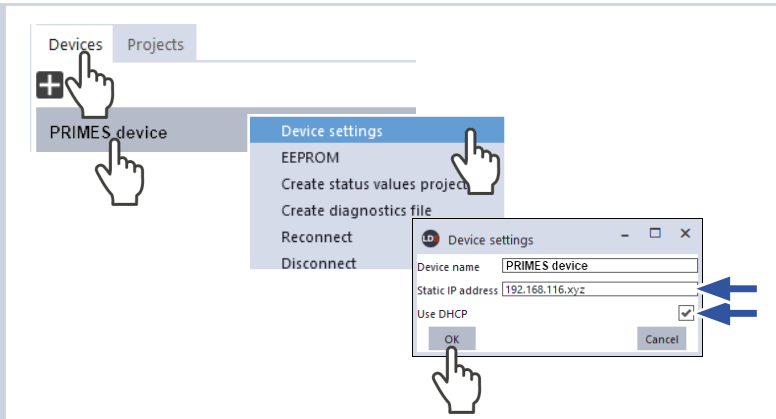

9.2.4 Disconnect and switch off the device

1. Click on the **Devices** tab.
2. Right-click on the device and select the **Disconnect** menu point.
 - ➔ The device is no longer connected to the LDS.
3. Switch off the device.
4. If necessary, disconnect the electrical connections.

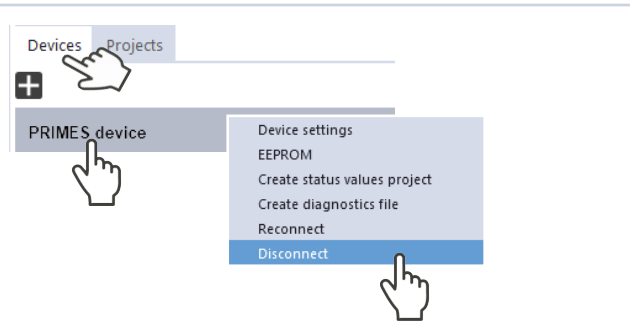

9.3 General information about working with the LDS

This chapter contains general information about the LDS. Read this general information before turning to the following chapters on the various measurement modes.

9.3.1 Open „Device control“ menu

1. Click on the **Devices** tab.
 2. Select the device and click on the device function **Scanner** below the device name.
- 👁 The **Device control** menu with the Measuring modes sections opens.

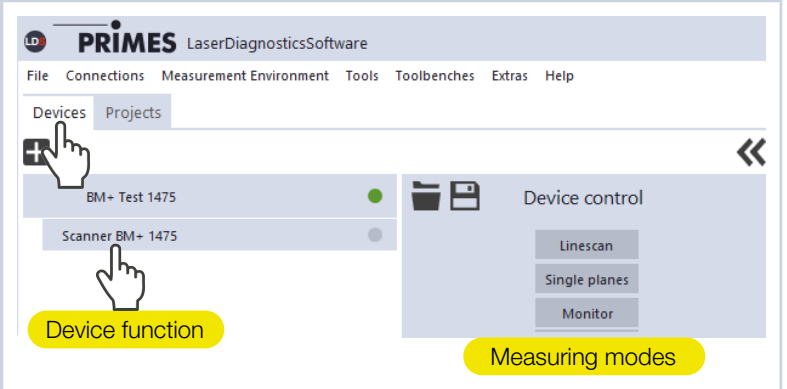

9.3.2 Open a measuring mode

The desired measuring mode is selected in the **Device control** menu. The following measuring modes are available:

- **Linescan** (see chapter 9.6 „Linescan“ on page 49)
- **Single planes** (see chapter 9.4 „Single planes“ on page 32)
- **Monitor** (see chapter 9.5 „Monitor“ on page 42)

- ▶ After opening the **Device control** menu, click the button of the desired measuring mode, for example **Single planes**

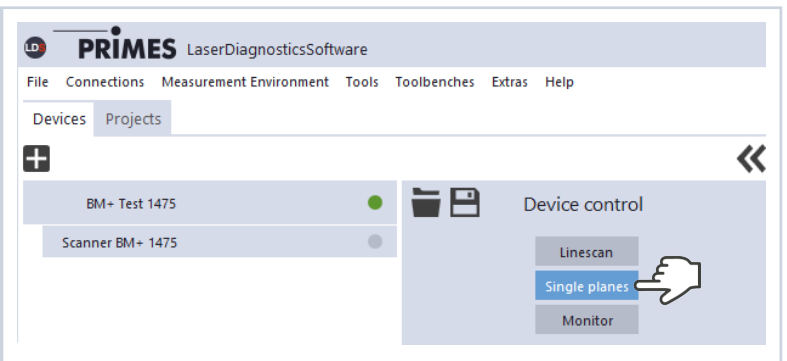

- 👁 A drop-down list for changing the measuring mode appears in the upper area of the **Device control** menu.
- Change measuring mode:**
1. Click on the arrow to open the drop-down list.
 2. Select measuring mode.

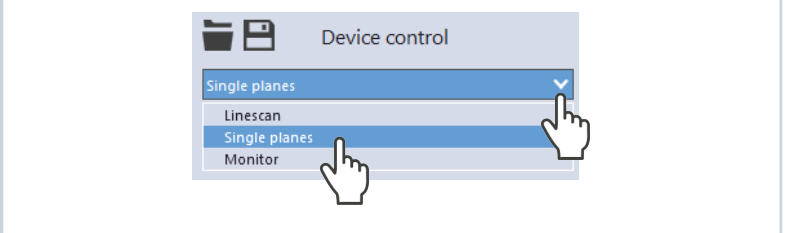

After selecting the measuring mode, the corresponding toolbench is opened.

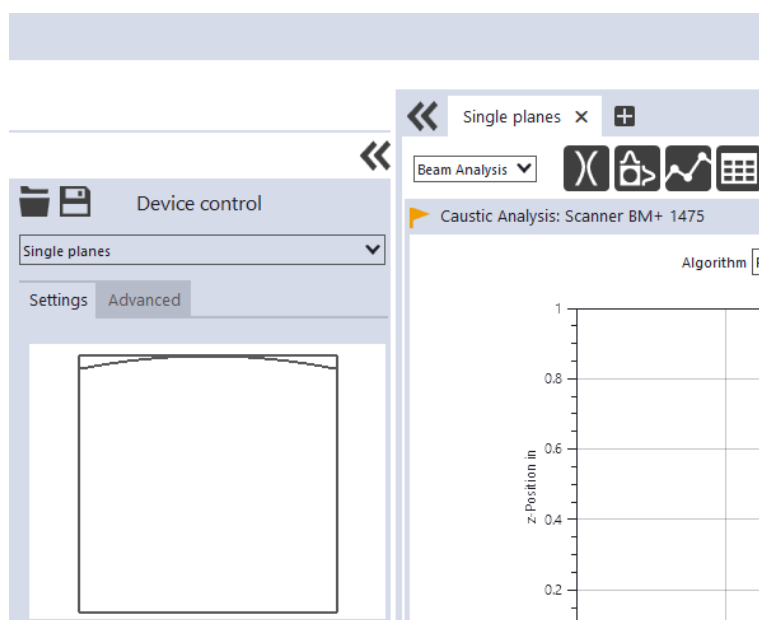

If the toolbench has been closed, re-open it by clicking the **Open measurement toolbench** button.

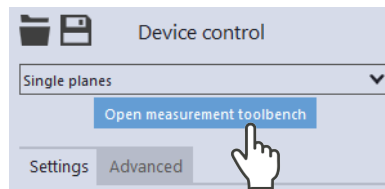

9.3.3 Enter parameters and activate

Be aware that when configuring settings in one mode, some options are also applied in other modes as well. For example, if you enter a parameter in the **Single planes** mode, it will be automatically applied to all other modes that use this same parameter.

To transfer a parameter value entered in the **Device control** menu to the active configuration, it must be confirmed with the Enter key.

1. Enter the desired value in the parameter field.
- After selecting the measuring mode, the corresponding toolbench is opened.
2. Confirm the entry by pressing the Enter key.
- The field returns to its original background color.

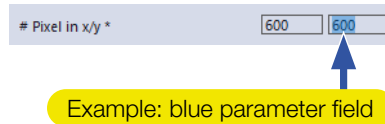

9.3.4 Move axes

Within all measuring modes, the measuring tip can be moved to a defined y-position (feed direction of the rotating disk).

1. Click on the **Advanced** tab.
2. Click on the arrow to open the drop-down list.

Use one of the following options:

- ▶ Enter a value in the parameter field and confirm the entry with the Enter key.
- ▶ Use the slider below the input field.

3. Click on the **Move to y-position** button.

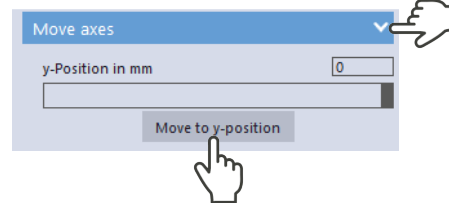
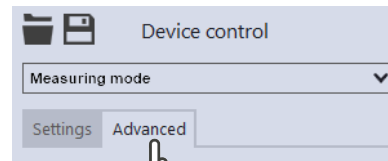

👁️ The **Confirmation** window appears.

4. If necessary, switch off the laser.
 5. Check the **Acknowledge** box and click **OK**.
- ▶ The measuring tip is moved to the entered y-position.

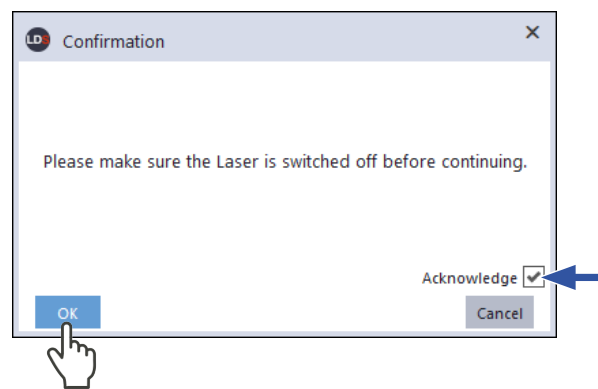



9.3.5 Saving options

The LDS offers (up to) three different options for saving. They differ by the storage location and the selection of the data to be saved.

When saving / loading a configuration, note that the command is called in a certain measurement mode, but the saved / loaded data set also includes the settings of the other measurement modes.

Saving data with an asterisk (*) on the PC:

All data marked with an asterisk in the **Device control** menu can be saved to a preset file with the extension **.pre** on the PC.

- ▶ To save a configuration, click on the icon .
- ▶ To load a configuration click on the icon .



Save data with an asterisk (*) in the EEPROM of the device:

All options marked with an asterisk in the **Device control** menu can be saved in the EEPROM in the device. In this case, the settings will be retained even if the device is switched off or disconnected from the power supply.

1. Click on the **Advanced** tab.
2. Click on the **Save device settings** button.

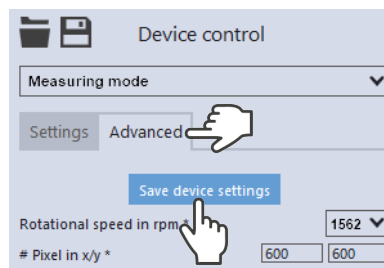

Save all settings in the LDS:

With these buttons you can save or load all settings of the **Device control** menu. The storage is made device-related in the local installation of the LDS.

1. Click on the **Settings** tab.
2. Use one of the following options:
 - ▶ Click the **Save current parameters** button to save the settings of the connected device.
 - ▶ Click on the **Load last parameters** button to load the last saved settings.

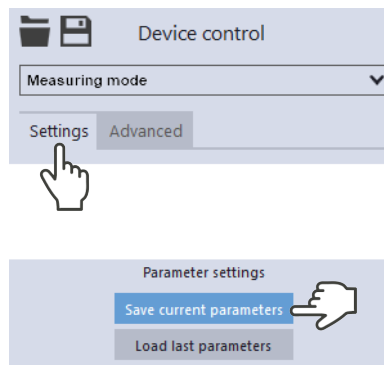

9.3.6 Considering the messages in the LaserDiagnosticsSoftware LDS during measurement

If problems occur during a measurement, the LaserDiagnosticsSoftware LDS displays them in different categories and different colors.

<p>Notes</p> <p>Notes provide assistance in interpreting the measurement results and are displayed in a blue window.</p> <p>Use one of the following options:</p> <ul style="list-style-type: none"> ▶ Click on the warning triangle in the footer to display / hide the window. ▶ If applicable, click the Next message button to display more messages of the same category. ▶ Click the Confirm button to remove the displayed message. 	
<p>Warnings</p> <p>Non-safety-critical problems that influence the quality of the measurement results, for example, are displayed in a yellow window.</p> <p>Use one of the following options:</p> <ul style="list-style-type: none"> ▶ Click on the warning triangle in the footer to display / hide the window. ▶ If applicable, click the Next message button to display more messages of the same category. ▶ Click the Confirm button to remove the displayed message. 	
<p>Safety critical device errors</p> <p>Safety-critical problems that can result in damage / destruction of the device are displayed in a red window.</p> <p>In this case, proceed as follows:</p> <ol style="list-style-type: none"> 1. Fix the problem immediately. 2. Click the Confirm button to remove the message. <p>👁️ The message disappears. If the problem is not fixed, then the message appears again shortly afterwards.</p> <ol style="list-style-type: none"> 3. Do not proceed with the measurement until the problem is solved. 	

9.4 Single planes

In **Single planes** measuring mode, single planes are measured at selected z-positions. Measurement window size and gain can be set automatically or determined freely. You can also have the software search the laser beam automatically within the entire measurement range.

To measure a manual caustic (see chapter 9.4.6 „Manual caustic measure“ on page 39), several planes can be measured — either individually or by means of a series measurement. Therefore, an increment along the z-axis can be configured. Since the BeamMonitor BM+ does not have a z-axis, the laser or the device must be moved according to the entered value. With this procedure, a manual caustic can be measured.

9.4.1 Settings

1. Click on the **Settings** tab.
2. Edit the options according to the explanations in Tab. 9.1 on page 32.

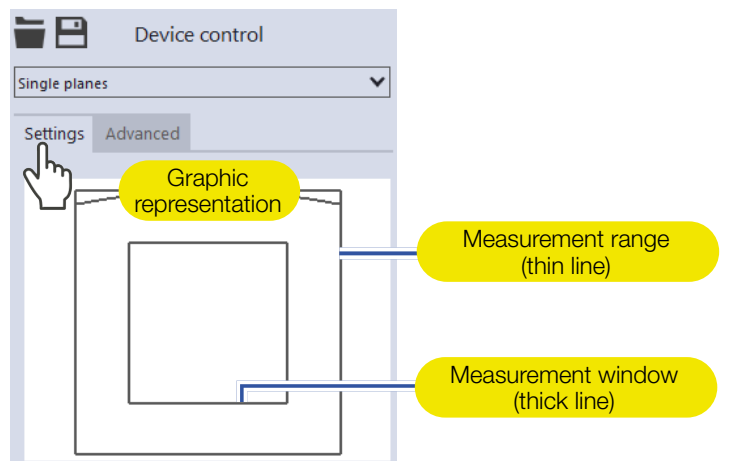

Option	Explanation
Graphic representation	<p>In a window in the upper area of the Settings tab, the measurement plane is displayed graphically. Displayed will be:</p> <ul style="list-style-type: none"> • the entire measurable area (measurement range, thin lines) • the area to be recorded (measurement window, thick lines) • after performing a beam find and during the measurements, a false color view of the recorded area <p>To create and move the measurement window:</p> <ul style="list-style-type: none"> ▶ To create a new measurement window, position the mouse pointer anywhere within the measurement range. Drag while holding down the left mouse button. Keep the mouse button pressed until the measurement window meets your requirements. ▶ To move the measurement window to another location, position the mouse pointer over the measurement window. Drag while holding down the right mouse button. <p>With a laser beam displayed:</p> <ul style="list-style-type: none"> ▶ To zoom to the center of the graphic representation, first move the mouse pointer over the graphic representation until the plus / minus buttons appear. Then press the buttons. ▶ To zoom in on the position of the mouse pointer, position the mouse pointer anywhere within the graphic representation. Then turn the mouse wheel. ▶ To zoom to the size of the measuring range. Position the mouse pointer within the measuring range. Then double-click left.
Reset measurement window	<ul style="list-style-type: none"> ▶ Click this button to maximize the measurement window and simultaneously center it in the measurement range.

Tab. 9.1: Options in the **Device control > Settings** tab of the **Single plane** measuring mode

Option	Explanation
<i>z-Increment in mm</i>	<p>This option automatically defines the position of the next measurement on the z-axis (see chapter 9.4.6 „Manual caustic measure“ on page 39).</p> <p>Since the BeamMonitor BM+ does not have a z-axis, the laser or the device must be moved according to the entered value.</p> <ul style="list-style-type: none"> ▶ Enter the z increment in mm.
<i>Manual z-position in mm</i>	<p>This option defines the position of the next measurement on the z-axis (see chapter 9.4.6 „Manual caustic measure“ on page 39).</p> <p>Since the BeamMonitor BM+ does not have a z-axis, the laser or the device must be moved according to the entered value.</p> <ul style="list-style-type: none"> ▶ Enter the manual z-position in mm.
<i>Power P in W *</i>	<p>To calculate the power density, the laser power used must be entered. Otherwise, the measured amplitudes are given directly in counts.</p> <ul style="list-style-type: none"> ▶ Enter the laser power used during measurement.
<i>autom. Measurement window</i>	<p>If this option is enabled, then the measurement window size will be set automatically.</p> <ul style="list-style-type: none"> ▶ Set the check mark to enable the option.
<i>Window size in mm</i>	<p>If the <i>autom. Measurement window</i> option is disabled, the size of the measurement window can be set manually. Use one of the following options:</p> <ul style="list-style-type: none"> ▶ Enter the length and width in the corresponding fields. ▶ Position the mouse pointer anywhere within the measurement range and drag while holding down the left mouse button. Keep the mouse button pressed until the measurement window meets your requirements.
<i>Position in mm</i>	<p>Use one of the following options to adjust the position of the measurement window:</p> <ul style="list-style-type: none"> ▶ Enter the x-position / y-position in the corresponding fields. ▶ Position the mouse pointer within the measurement window. Then drag while holding down the right mouse button.
<i>autom. Gain</i>	<p>If this option is enabled, the gain is set automatically.</p> <ul style="list-style-type: none"> ▶ Set the check mark to enable the option.
<i>Gain in dB</i>	<p>If the <i>autom. Gain</i> option is disabled, the gain can be set manually. The option can be used to control the sensitivity of the detector. Use one of the following options:</p> <ul style="list-style-type: none"> ▶ Enter a value in the input field. ▶ Use the slider below the input field.
<i>Time series</i>	<p>A time series consists of several single plane measurements with the same settings.</p>
<i>Number of measurements *</i>	<ul style="list-style-type: none"> ▶ Enter the desired number of single plane measurements of the time series.
<i>Interval between measurements in s *</i>	<ul style="list-style-type: none"> ▶ Enter the pause between the single plane measurements of the time series. This is the time gap between the end of one measurement and the start of the next.
<i>Find beam</i>	<p>This option enables an automatic beam search with an automated measuring window size and measurement. The laser beam is automatically searched for in the entire measuring range. Measurement window size and gain are set automatically. The measured plane is then displayed in the graphic display.</p> <ul style="list-style-type: none"> ▶ Click on the button to start the beam search. <p>Note that the determined measurement data will not be saved in the project tree of the <i>Projects</i> tab.</p>

Tab. 9.1: Options in the ***Device control > Settings*** tab of the ***Single plane*** measuring mode

Option	Explanation
Parameter settings	All settings in the Device control menu can be individually saved for each device. The saving location is the local installation of the LDS. These and other options for saving / loading configurations are described in chapter 9.3.5 „Saving options“ on page 30.
Save current parameters	► Click this button to save all current settings of the connected device.
Load last parameters	► Click this button to load the last saved device configuration.

Tab. 9.1: Options in the **Device control** > **Settings** tab of the **Single plane** measuring mode

9.4.2 Advanced settings

<ol style="list-style-type: none"> Click on the Advanced tab. Edit the options according to the explanations in Tab. 9.2 on page 35. 	
---	--

Option	Explanation
Save device settings	<p>All options marked with an asterisk in the Device control menu can be saved in the EEPROM of the device.</p> <p>These and other options for saving / loading configurations are described in chapter 9.3.5 „Saving options“ on page 30.</p>
Rotational speed in rpm *	For the BeamMonitor BM+, the rotation speed of the measuring tip is always 1 562 rpm.
# Pixel in x/y *	<p>The number of pixels determines the resolution of the measurement.</p> <ul style="list-style-type: none"> ▶ Enter the resolution in x-direction / y-direction in the corresponding fields.
Calibrated wavelength(s) in nm *	<p>The “calibrated wavelength” is the wavelength at which the device has been validated. This is stored in the device and is displayed in the LDS.</p>
Used wavelength in nm *	<p>To calculate the beam quality factor M^2, the used wavelength must be entered. Depending on the display in the option Calibrated wavelength(s) in nm, the used wavelength can be entered in a defined range.</p> <p>For example, with a „calibrated wavelength“ of 1 064 nm, the used wavelength can be entered from 1 000 - 1 100 nm.</p> <p>Use one of the following options to set the wavelength of the laser used:</p> <ul style="list-style-type: none"> ▶ Enter a value in the input field. ▶ Use the slider below the input field.
Focal length of focusing optics in mm *	<p>If several planes of a caustic have been measured, the caustic fit and the entered focal length are used to calculate the raw beam diameter on the focusing optics.</p> <ul style="list-style-type: none"> ▶ Enter the used focal length of the focusing optics of the laser system.
Averaging *	<p>If this option is enabled, different algorithms for averaging a plane measurement can be selected in the drop-down list. Averaging over several measurements can be useful, for example, when measuring a laser with significant power fluctuations.</p> <ol style="list-style-type: none"> Set the check mark to enable the option Select an algorithm from the drop-down list: <ul style="list-style-type: none"> • Arithmetic Average: The measured values for each pixel are added together and divided by the number of planes. • Max. intensity per pixel: The values from all the measurements are compared for each pixel and only the maximum value for each one is displayed. • Max. lines: The values from all the measurements are compared for each line (meaning the line issuing from the measuring device in the x-direction for example) and only the maximum value for each one is displayed.
Number of averaged planes *	<ul style="list-style-type: none"> ▶ With the Averaging option enabled, enter the number of plane measurements for averaging.

Tab. 9.2: Options in the **Device control** > **Advanced** tab of the **Single planes** measuring mode

Option	Explanation
Move axes	With this option you can move to a defined y-position. Use one of the following options: <ul style="list-style-type: none"> ▶ Enter a value in the input field. ▶ Use the slider below the input field. This option is described in chapter 9.3.4 „Move axes“ on page 29.

Tab. 9.2: Options in the **Device control > Advanced** tab of the **Single planes** measuring mode

9.4.3 Search laser beam automatically with the find beam function

1. Follow the warning messages in chapter 9.1 on page 22.
2. Switch on the laser.
3. Click on the **Settings** tab.
4. Click on the **Find beam** button.
 - ➔ The laser beam is automatically searched for in the entire measuring range. The measurement window and gain are set automatically.

👁 If the search is successful, the laser beam is displayed in the graphic representation.

If the beam is not displayed:

- ▶ Check again the correct alignment of the device on the x-y plane according to chapter 7.2.3 on page 15.
 - ▶ Check the direction of the beam entrance.
 - ▶ Adjust the gain.
 - ▶ Choose a different z-position.
 - ▶ Increase the laser power (step by step).
5. If necessary, adjust the measurement window manually according to 9.4.4 on page 38.
 6. Start the measurement according to chapter 9.4.5 on page 39.

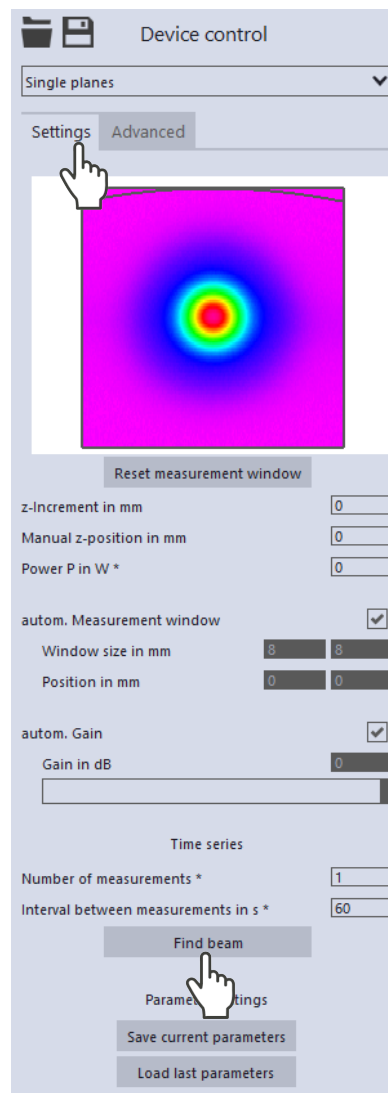

9.4.4 Adjust the size and position of the measurement window manually

1. Click on the **Settings** tab.
2. Make sure that the **autom. Measurement window** option is not enabled. Otherwise, the manual setting may be overwritten when starting a measurement.
3. Use one of the following options to adjust the size of the measurement window:
 - ▶ Enter the length and width in the corresponding fields.
 - ▶ Position the mouse pointer anywhere within the measurement range and drag while holding down the left mouse button. Keep the mouse button pressed until the measurement window meets your requirements.
4. Use one of the following options to adjust the position of the measurement window:
 - ▶ Enter the x-position / y-position in the corresponding fields.
 - ▶ Position the mouse pointer within the measurement window. Then drag while holding down the right mouse button.
5. Start the measurement according to chapter 9.4.5 on page 39.

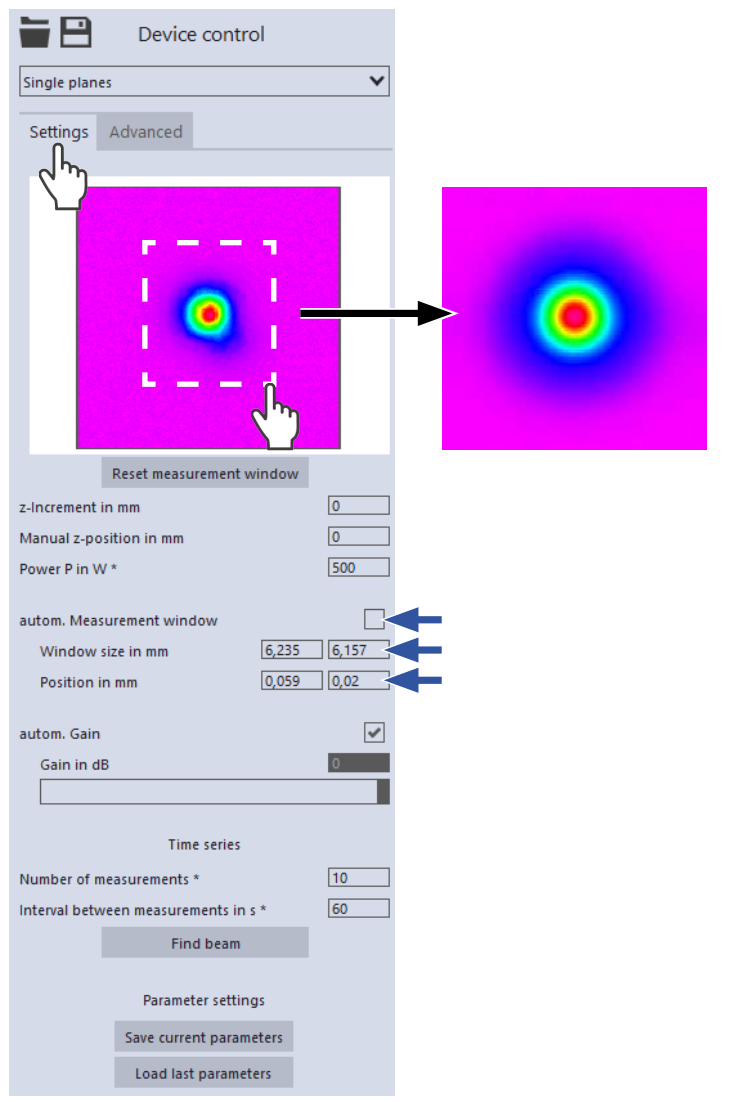

9.4.5 Start measurement

1. Follow the warning messages in chapter 9.1 on page 22.
 2. Click the **Start** button.
➔ The measurement begins.
- Optional:**
- ▶ Click the **Stop** button to abort the measurement.
 - ▶ Click the **Stop Rotation** button to stop the rotation of the measuring tip.
- 👁️ During the measurement, the progress is shown in the following indicators:
- Measuring plane**
While the indicator is rotating, the measurement is performed.
- Measurement completed**
After successful measurement, the indicator lights up green.
3. Switch off the laser after the measurement is completed, unless you want to perform further measurements.

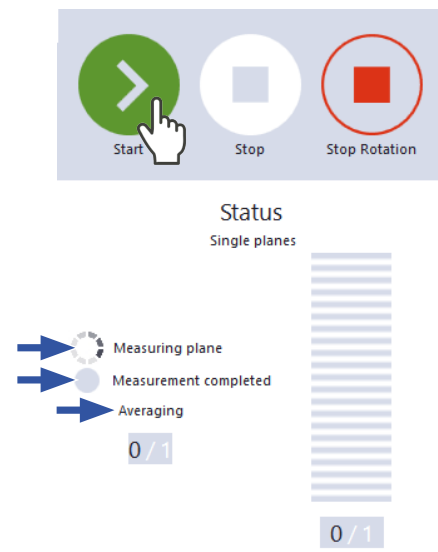

Averaging (if enabled):
The indication shows the measured planes that are used to average a measured value.

9.4.6 Manual caustic measure

In the single plane measurement mode, further measurements can be performed at other z-positions.



Since the BeamMonitor BM+ does not have a z-axis, the laser or the device must be moved according to the entered value. With this procedure, a manual caustic can be measured.

Single measurement with manual input of the z-position:

1. Click on the **Settings** tab.
2. In the **z-position in mm** field, enter the desired position of the next plane to be measured.
3. Start and stop the measurement according to chapter 9.4.5 on page 39.

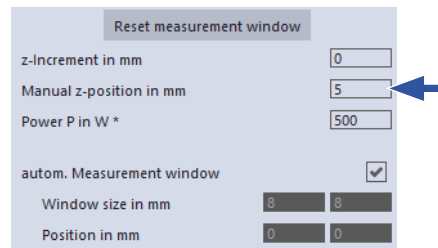

Single measurements using z-increment spacing:

1. Click on the **Settings** tab.
2. Enter the spacing for the further measurements in the **z-Increment in mm** field.
3. Start the measurement according to chapter 9.4.5 on page 39 and wait until the measurement is completed.
 - ➔ The measured plane is one z-increment away from the previously measured plane.
4. Start a measurement again and wait until the measurement is finished.
 - ➔ The measured plane is one z-increment away from the previously measured plane.
5. Repeat the last step as often as you like.

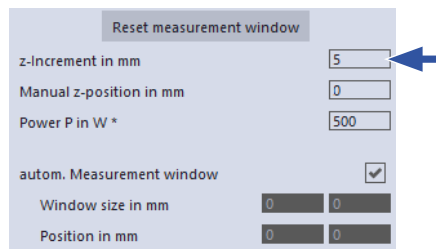

Series measurement using z-increment spacing:

The combination of the **Time series** and **z-Increment in mm** options enables measuring a free caustic in one run.

1. Click on the **Settings** tab.
2. Enter the spacing for the planes to be measured in the **z-Increment in mm** field.
3. In the **Number of measurements** and **Interval between measurements in s** fields, enter the number of measurements and the interval. The interval is the time between the end of one measurement and the start of the next.
4. Start the series measurement according to chapter 9.4.5 on page 39 and wait until the measurement is finished.

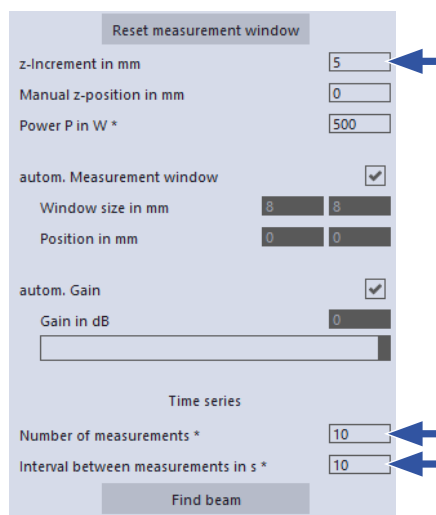

9.4.7 Display of the measurement results

The measurement results are displayed in the open tools after the measurement has been completed (see below). We recommend checking the quality of the results after a measurement. Depending on the results, it may seem necessary to repeat the measurement with improved measurement setup or changed parameters.

For a detailed description of the file management and evaluation of the measured data, please refer to the separate operating manual LDS.

The screenshot displays the BeamMonitor software interface with two main analysis windows open: 'Caustic Analysis: FM+ 120 Caustic' and 'Plane Analysis: Scanner BM+ 1475'.

Caustic Analysis: FM+ 120 Caustic

- Algorithm: Rotated moments
- Graph: Shows z-Position in mm (55 to 70) vs Radius in μm (-400 to 400). It includes data for Caustic fit, Plane radius a, Caustic fit b, and Plane radius b.
- Results Table:

	Rot. mom., a	Rot. mom., b
Beam waist position z_0 in mm	62,52	62,98
Beam waist radius r_0 in μm	117,02	115,55
Rayleigh length z_R in mm	3,57	3,57
Divergence angle θ in mrad	65,58	64,77
Beam quality factor M^2	11,27	10,99
BPP in $\text{mm} \cdot \text{mrad}$	3,84	3,74
Ellipticity at Δz_0	1,01	1,01
$\Delta z_0 / z_R$	-0,13	-0,13
Misalignment in zx-plane in mrad	-4,85	-4,85
Misalignment in zy-plane in mrad	-0,16	-0,16
Beam direction in mrad	4,85	4,85

Plane Analysis: Scanner BM+ 1475

- Graphs: Shows Amplitude in cts vs x_{abs} in μm (Cross section x) and Amplitude in cts vs y_{abs} in μm (Cross section y).
- 2D Plot: Shows a color-coded intensity map with a central spot and axes.
- Parameters: x in μm : 44, y in μm : 33, Amp. in cts: 11188.
- Results Table:

z-Position in mm	0,000
Radius a in μm	2426,52
Radius b in μm	2193,64
Ellipticity	0,90
Azimuth angle ϕ in $^\circ$	-1,4

9.5 Monitor

In **Monitor** measuring mode, measuring planes can be continuously observed in a false-color image. The laser beam can be automatically searched by the software in the entire measurement range.

After a successful search the measurement can be run as long as desired. During the measurement, data is continuously being read out and displayed in the graphic view. Measurement data is not saved in the project tree of the **Projects** tab.

9.5.1 Settings

1. Click on the **Settings** tab.
2. Edit the options according to the explanations in Tab. 9.3 on page 42.

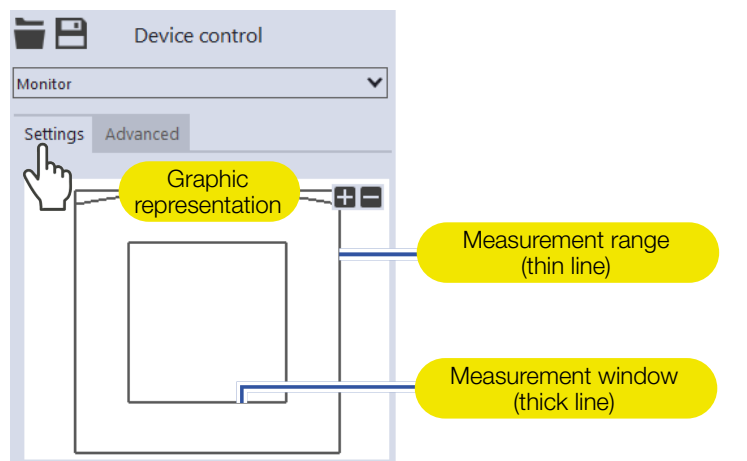

Option	Explanation
Graphic representation	<p>In a window in the upper area of the Settings tab, the measurement plane is displayed graphically. Displayed will be:</p> <ul style="list-style-type: none"> • the entire measurable area (measurement range, thin lines) • the area to be recorded (measurement window, thick lines) • after performing a beam find and during the measurements, a false color view of the recorded area <p>To create and move the measurement window:</p> <ul style="list-style-type: none"> ▶ To create a new measurement window, position the mouse pointer anywhere within the measurement range. Drag while holding down the left mouse button. Keep the mouse button pressed until the measurement window meets your requirements. ▶ To move the measurement window to another location, position the mouse pointer over the measurement window. Drag while holding down the right mouse button. <p>With a laser beam displayed:</p> <ul style="list-style-type: none"> ▶ To zoom to the center of the graphic representation, first move the mouse pointer over the graphic representation until the plus / minus buttons appear. Then press the buttons. ▶ To zoom in on the position of the mouse pointer, position the mouse pointer anywhere within the graphic representation. Then turn the mouse wheel. ▶ To zoom to the size of the measuring range. Position the mouse pointer within the measuring range. Then double-click left.
Reset measurement window	<ul style="list-style-type: none"> ▶ Click this button to maximize the measurement window and simultaneously center it in the measurement range.

Tab. 9.3: Options in the **Device control > Settings** tab of the **Monitor** measuring mode

Option	Explanation
Window size in mm	<p>If the autom. Measurement window option is disabled, the size of the measurement window can be set manually. Use one of the following options:</p> <ul style="list-style-type: none"> ▶ Enter the length and width in the corresponding fields. ▶ Position the mouse pointer anywhere within the measurement range and drag while holding down the left mouse button. Keep the mouse button pressed until the measurement window meets your requirements.
Position in mm	<p>Use one of the following options to adjust the position of the measurement window:</p> <ul style="list-style-type: none"> ▶ Enter the x-position / y-position in the corresponding fields. ▶ Position the mouse pointer within the measurement window. Then drag while holding down the right mouse button.
Gain in dB	<p>The option can be used to control the sensitivity of the detector. Use one of the following options:</p> <ul style="list-style-type: none"> ▶ Enter a value in the input field. ▶ Use the slider below the input field.
Find beam	<p>This option enables an automatic beam search with an automated measuring window size and measurement. The laser beam is automatically searched for in the entire measuring range. Measurement window size and gain are set automatically. The measured plane is then displayed in the graphic display.</p> <ul style="list-style-type: none"> ▶ Click on the button to start the beam search. <p>Note that the determined measurement data will not be saved in the project tree of the Projects tab.</p>
Parameter settings	<p>All settings in the Device control menu can be individually saved for each device. The saving location is the local installation of the LDS.</p> <p>These and other options for saving / loading configurations are described in chapter 9.3.5 „Saving options“ on page 30.</p>
Save current parameters	<ul style="list-style-type: none"> ▶ Click this button to save all current settings of the connected device.
Load last parameters	<ul style="list-style-type: none"> ▶ Click this button to load the last saved device configuration.

Tab. 9.3: Options in the **Device control > Settings** tab of the **Monitor** measuring mode

9.5.2 Advanced settings

1. Click on the **Advanced** tab.
2. Edit the options according to the explanations in Tab. 9.4 on page 44.

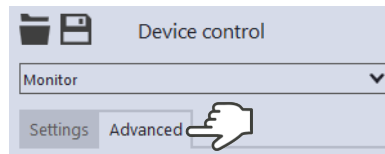

Option	Explanation
Save device settings	All options marked with an asterisk in the Device control menu can be saved in the EEPROM of the device. These and other options for saving / loading configurations are described in chapter 9.3.5 „Saving options“ on page 30.
Rotational speed in rpm *	For the BeamMonitor BM+, the rotation speed of the measuring tip is always 1 562 rpm.
# Pixel in x/y *	The number of pixels determines the resolution of the measurement. ▶ Enter the resolution in x-direction / y-direction in the corresponding fields.
Calibrated wavelength(s) in nm *	The “calibrated wavelength” is the wavelength at which the device has been validated. This is stored in the device and is displayed in the LDS.
Used wavelength in nm *	To calculate the beam quality factor M^2 , the used wavelength must be entered. Depending on the display in the option Calibrated wavelength(s) in nm , the used wavelength can be entered in a defined range. For example, with a „calibrated wavelength“ of 1 064 nm, the used wavelength can be entered from 1 000 - 1 100 nm. Use one of the following options to set the wavelength of the laser used: ▶ Enter a value in the input field. ▶ Use the slider below the input field.
Power P in W *	To calculate the power density, the laser power used must be entered. Otherwise, the measured amplitudes are given directly in counts. ▶ Enter the laser power used during measurement.
Move axes	With this option you can move to a defined y-position. Use one of the following options: ▶ Enter a value in the input field. ▶ Use the slider below the input field. This option is described in chapter 9.3.4 „Move axes“ on page 29.

Tab. 9.4: Options in the **Device control > Advanced** tab of the **Monitor** measuring mode

9.5.3 Search laser beam automatically with the find beam function

1. Follow the warning messages in chapter 9.1 on page 22.
2. Switch on the laser.
3. Click on the **Settings** tab.
4. Click on the **Find beam** button.
 - ➔ The laser beam is automatically searched for in the entire measuring range. The measuring window and gain are set automatically.

👁️ If the search is successful, the laser beam is displayed in the graphic representation.

If the beam is not displayed:

- ▶ Check again the correct alignment of the device on the x-y plane according to chapter 7.2.3 on page 15.
 - ▶ Check the direction of the beam entrance.
 - ▶ Adjust the gain.
 - ▶ Choose a different z-position.
 - ▶ Increase the laser power (step by step).
5. If necessary, adjust the measuring window manually according to 9.5.4 on page 46.
 6. Start the measurement according to chapter 9.5.5 on page 47.

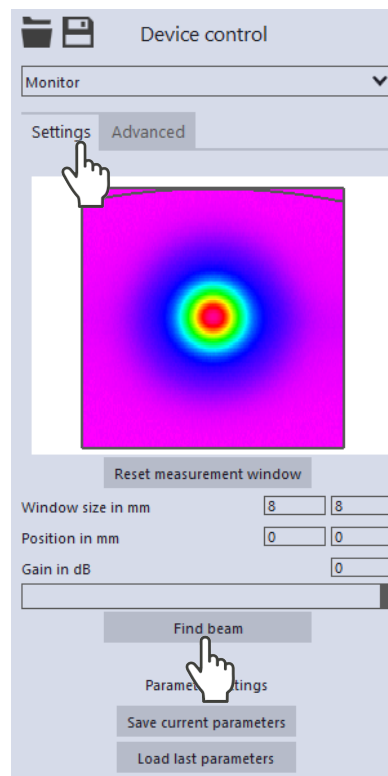

9.5.4 Adjust the size and position of the measurement window manually

1. Click on the **Settings** tab.
2. Use one of the following options to adjust the size of the measurement window:
 - ▶ Enter the length and width in the corresponding fields.
 - ▶ Position the mouse pointer anywhere within the measurement range and drag while holding down the left mouse button. Keep the mouse button pressed until the measurement window meets your requirements.
3. Use one of the following options to adjust the position of the measurement window:
 - ▶ Enter the x-position / y-position in the corresponding fields.
 - ▶ Position the mouse pointer within the measurement window. Then drag while holding down the right mouse button.
4. Start the measurement according to chapter 9.5.5 on page 47.

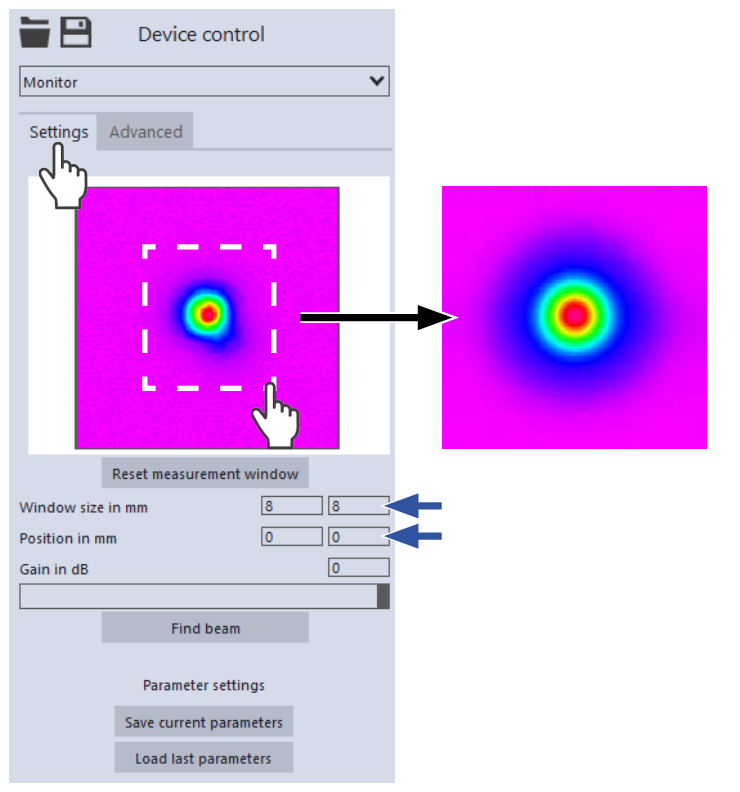

9.5.5 Start measurement



DANGER

Serious eye or skin injury due to laser radiation

If you use a continuous plane measurement in the **Monitor** measurement mode to align the device, note the following:

- ▶ Preferably align the device with a pilot laser where no dangerous reflections can occur.
- ▶ If the device is aligned with a laser class 4, dangerous reflections may occur. In this case, the alignment must be performed remotely behind a separating protective equipment. The protective equipment must block the radiation or attenuate it to a non-hazardous level.

1. Follow the warning messages in chapter 9.1 on page 22.

2. Click the **Start** button.
▶ The measurement begins.

Optional:

- ▶ Click the **Stop** button to abort the measurement.
- ▶ Click the **Stop Rotation** button to stop the rotation of the measuring tip.

👁 Data is continuously read out from the previously set measurement window and displayed in the false color view.

3. Switch off the laser after the measurement is completed, unless you want to perform further measurements.

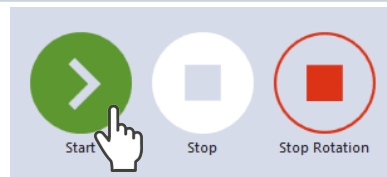

Status
Monitor



9.5.6 Display of the measurement results

During the measurement, data is continuously being read out and displayed in the graphic view. Measurement data is not saved in the project tree of the **Projects** tab.

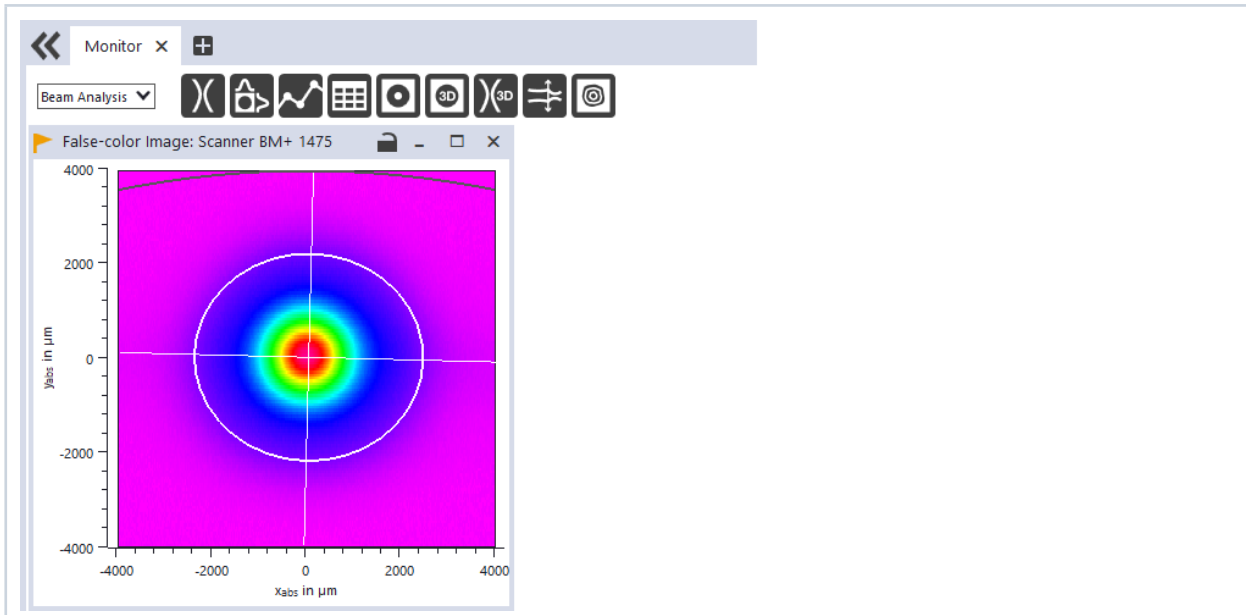

9.6 Linescan

In measuring mode **Linescan**, the laser beam is measured at a defined position on the y-axis over a specific period of time. The line width, line center and position on the y-axis are freely adjustable. The measuring tip of the BeamMonitor BM+ is moved to a fixed y-position. At this position, it measures the power density on a single measuring path with every rotation of the measurement tip. The measurement is carried out over a defined period of time or until it is manually aborted.

9.6.1 Settings

1. Click on the **Settings** tab.
2. Edit the options according to the explanations in Tab. 9.5 on page 49.

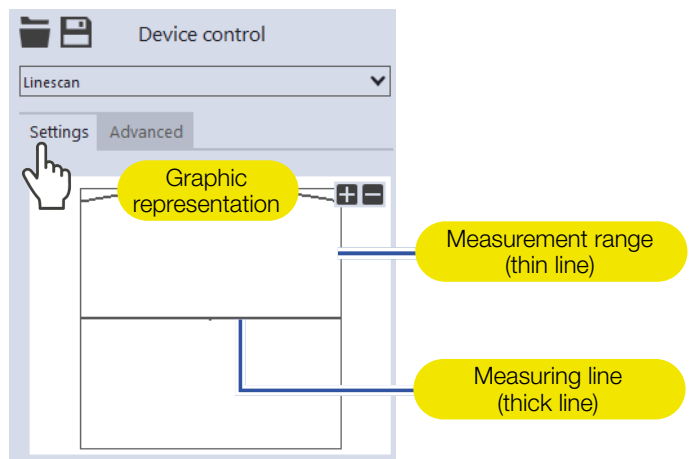

Option	Explanation
Graphic representation	<p>In a window in the upper area of the Settings tab, the measurement plane is displayed graphically. Displayed will be:</p> <ul style="list-style-type: none"> • the entire measurable area (measurement range, thin lines) • the measuring line to be recorded (Measuring line on a plane, thick lines) • after performing a beam find and during the measurements, a false color view of the recorded area <p>To create and move the measuring line:</p> <ul style="list-style-type: none"> ▶ To create a new measuring line, position the mouse pointer anywhere within the measurement range. Drag while holding down the left mouse button. Keep the mouse button pressed until the measuring line meets your requirements. ▶ To move the measuring line to another location, position the mouse pointer over the measuring line. Drag while holding down the right mouse button. <p>With a laser beam displayed:</p> <ul style="list-style-type: none"> ▶ To zoom to the center of the graphic representation, first move the mouse pointer over the graphic representation until the plus / minus buttons appear. Then press the buttons. ▶ To zoom in on the position of the mouse pointer, position the mouse pointer anywhere within the graphic representation. Then turn the mouse wheel. ▶ To zoom to the size of the measuring range. Position the mouse pointer within the measuring range. Then double-click left.
Line center in mm	<p>Use one of the following options to adjust the position of the measuring line:</p> <ul style="list-style-type: none"> ▶ Enter the x-position / y-position of the line center in the corresponding fields. ▶ Position the mouse pointer within the measurement window. Then drag while holding down the right mouse button.

Tab. 9.5: Options in the **Device control > Settings** tab of the **Linescan** measuring mode

Option	Explanation
Line width in mm	Use one of the following options to adjust the line width (length) and position: <ul style="list-style-type: none"> ▶ Enter the width (length) of the line. ▶ Position the mouse pointer at any point within the measurement area and drag while holding down the left mouse button. Keep the mouse button pressed until the length of the measuring line meets your requirements.
Gain in dB	The option can be used to control the sensitivity of the detector. Use one of the following options: <ul style="list-style-type: none"> ▶ Enter a value in the input field. ▶ Use the slider below the input field.
Measuring duration in s	<ul style="list-style-type: none"> ▶ Enter the duration of the measurement in s.
# Pixel in x	The number of pixels determines the resolution of the measurement. Use one of the following options: <ul style="list-style-type: none"> ▶ Enter a value in the input field. ▶ Use the slider below the input field.
Parameter settings	All settings in the Device control menu can be individually saved for each device. The saving location is the local installation of the LDS. These and other options for saving / loading configurations are described in chapter 9.3.5 „Saving options“ on page 30.
Save current parameters	<ul style="list-style-type: none"> ▶ Click this button to save all current settings of the connected device.
Load last parameters	<ul style="list-style-type: none"> ▶ Click this button to load the last saved device configuration.
Find beam	This option enables an automatic beam search with an automated measuring window size and measurement. The laser beam is automatically searched for in the entire measuring range. Measurement window size and gain are set automatically. The measured plane is then displayed in the graphic display. <ul style="list-style-type: none"> ▶ Click on the button to start the beam search. <p>Note that the determined measurement data will not be saved in the project tree of the Projects tab.</p>
Power P in W *	To calculate the power density, the laser power used must be entered. Otherwise, the measured amplitudes are given directly in counts. <ul style="list-style-type: none"> ▶ Enter the laser power used during measurement.

 Tab. 9.5: Options in the **Device control > Settings** tab of the **Linescan** measuring mode

9.6.2 Advanced settings

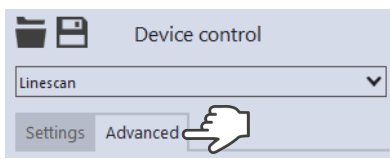
<ol style="list-style-type: none"> 1. Click on the Advanced tab. 2. Edit the options according to the explanations in Tab. 9.6 on page 51. 	
---	--

Option	Explanation
Save device settings	<p>All options marked with an asterisk in the Device control menu can be saved in the EEPROM of the device.</p> <p>These and other options for saving / loading configurations are described in chapter 9.3.5 „Saving options“ on page 30.</p>
Rotational speed in rpm *	For the BeamMonitor BM+, the rotation speed of the measuring tip is always 1 562 rpm.
Calibrated wavelength(s) in nm *	The “calibrated wavelength” is the wavelength at which the device has been validated. This is stored in the device and is displayed in the LDS.
Used wavelength in nm *	<p>To calculate the beam quality factor M^2, the used wavelength must be entered. Depending on the display in the option Calibrated wavelength(s) in nm, the used wavelength can be entered in a defined range.</p> <p>For example, with a „calibrated wavelength“ of 1 064 nm, the used wavelength can be entered from 1 000 - 1 100 nm.</p> <p>Use one of the following options to set the wavelength of the laser used:</p> <ul style="list-style-type: none"> ▶ Enter a value in the input field. ▶ Use the slider below the input field.
Move axes	<p>With this option you can move to a defined y-position. Use one of the following options:</p> <ul style="list-style-type: none"> ▶ Enter a value in the input field. ▶ Use the slider below the input field. <p>This option is described in chapter 9.3.4 „Move axes“ on page 29.</p>

Tab. 9.6: Options in the **Device control** > **Advanced** tab of the **Linescan** measuring mode

9.6.3 Search laser beam automatically with the find beam function

1. Follow the warning messages in chapter 9.1 on page 22.
2. Switch on the laser.
3. Click on the **Settings** tab.
4. Click on the **Find beam** button.
 - ➔ The laser beam is automatically searched for in the entire measuring range. The measuring line and gain are set automatically.

👁️ If the search is successful, the laser beam is displayed in the graphic representation.

If the beam is not displayed:

- ▶ Check again the correct alignment of the device on the x-y plane according to chapter 7.2.3 on page 15.
 - ▶ Check the direction of the beam entrance.
 - ▶ Adjust the gain.
 - ▶ Choose a different z-position.
 - ▶ Increase the laser power (step by step).
5. If necessary, adjust the measuring line manually according to 9.6.4 on page 53.
 6. Start the measurement according to chapter 9.6.5 on page 54.

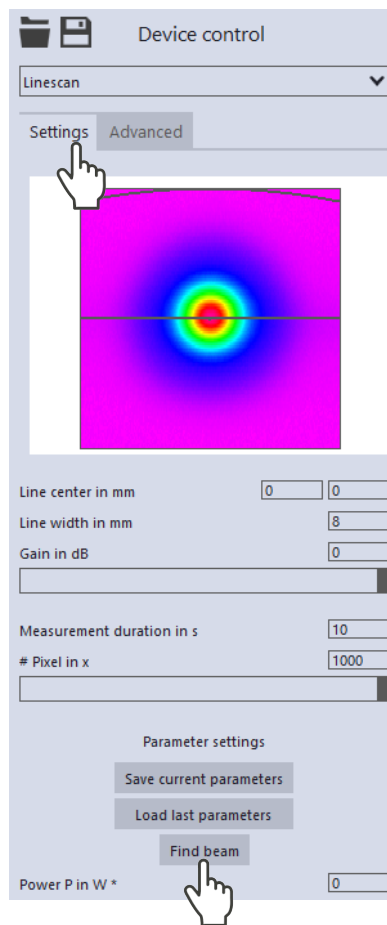

9.6.4 Adjust the width (length) and position of the measuring line manually

1. Click on the **Settings** tab.
2. Use one of the following options to adjust the line width (length):
 - ▶ Enter the width (length) of the line.
 - ▶ Position the mouse pointer at any point within the measurement area and drag while holding down the left mouse button. Keep the mouse button pressed until the length of the measuring line meets your requirements.
3. Use one of the following options to adjust the position of the measuring line:
 - ▶ Enter the x-position / y-position of the line center in the corresponding fields.
 - ▶ Position the mouse pointer within the measurement window. Then drag while holding down the right mouse button.
4. Start the measurement according to chapter 9.6.5 on page 54.



9.6.5 Start measurement

1. Follow the warning messages in chapter 9.1 on page 22.
2. Click the **Start** button.
➔ The measurement begins.

Optional:

- ▶ Click the **Stop** button to abort the measurement.
- ▶ Click the **Stop Rotation** button to stop the rotation of the measuring tip.

👁️ During the measurement, the progress is shown in the following indicators:

Measurement:

While the indicator is rotating, the measurement is running.

Measurement completed:

After successful measurement, the indicator lights up green.

3. Switch off the laser after the measurement is completed, unless you want to perform further measurements.

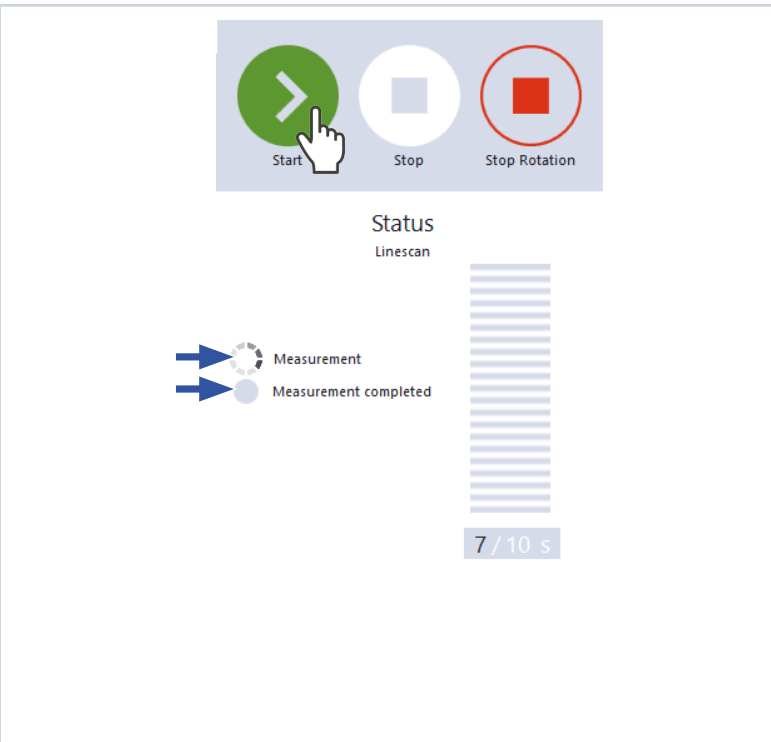

9.6.6 Display of the measurement results

The measurement results are displayed during and after the finished measurement in the opened tool (see below). We recommend checking the quality of the results after a measurement. Depending on the results, it may seem necessary to repeat the measurement with improved measurement setup or changed parameters.

For a detailed description of the file management and evaluation of the measured data, please refer to the separate operating manual LDS.

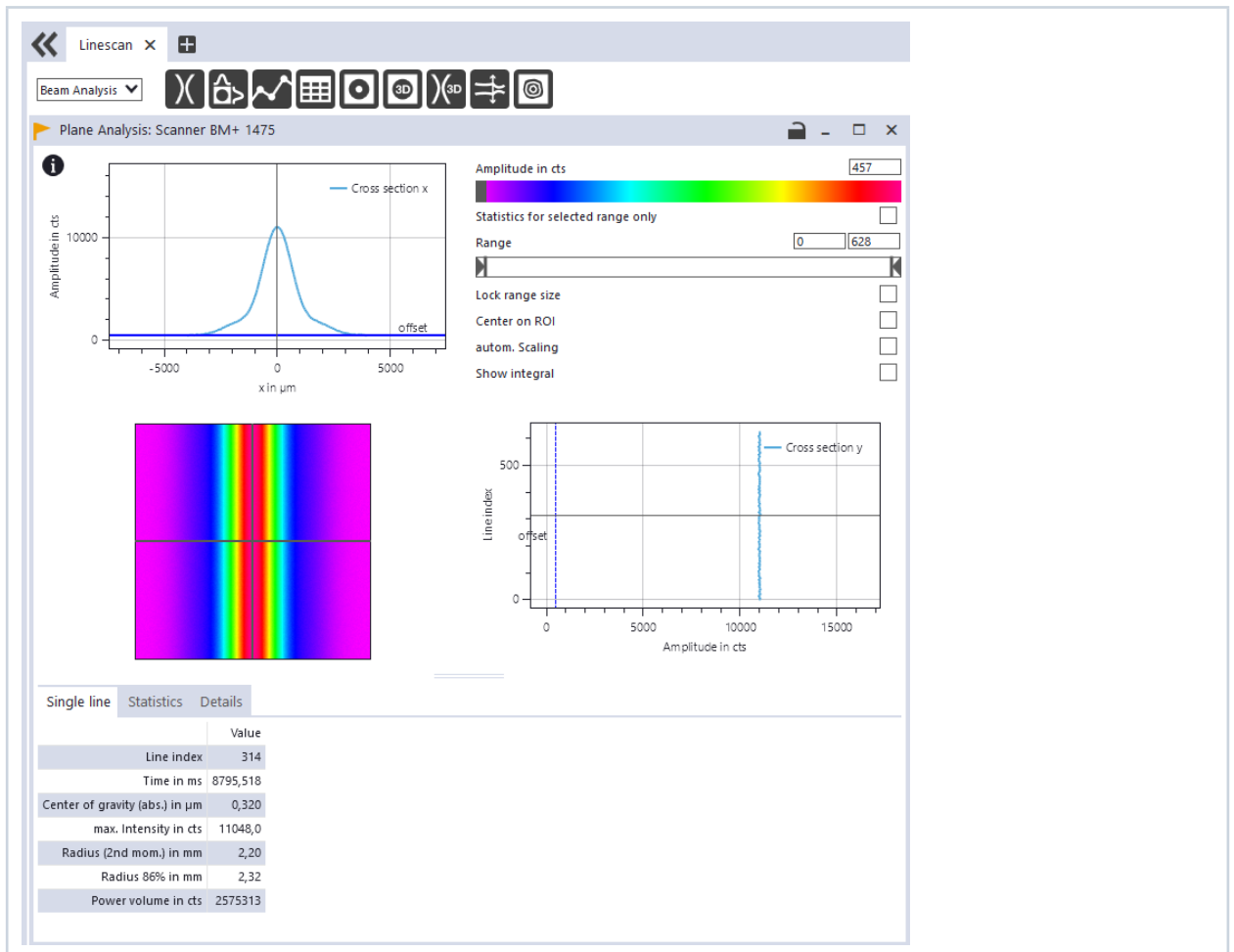

10 Troubleshooting

Error	Possible cause	Remedy
There is no connection between the BeamMonitor BM+ and the PC.	Network address of the PC is not within the range of the BeamMonitor BM+.	In Windows > Control panel > Network and Sharing Center, assign an IP address to your PC that is in the same address range as the PRIMES device (e.g. 192.168.116.xyz). The IP address of your PRIMES device can be found on the identification plate.
	The connection may be blocked by the firewall.	Enable the UDP port 20034 according to chapter 9.2.2 on page 25.
	An incorrect Ethernet card is selected.	Select the appropriate Ethernet card according to chapter 9.2.2 on page 25.
Error during a measurement	<ul style="list-style-type: none"> Error in the data transmission Processor crash in the measuring system Program execution error 	<ol style="list-style-type: none"> Restart the software. Switch off the supply voltage, switch it on again, and start another reset cycle. Restart the PC.
Apart from the ambient noise and zero offset, no measuring signal is available.	The laser is not switched on.	Switch on the laser.
	The device is not aligned correctly.	<ul style="list-style-type: none"> ▶ Check the device alignment to the laser beam. ▶ Please check that the beam path marked on the device is correct.
	The power density is too low.	Increase the laser power (step by step). The absolute power density should typically be a few kW/cm ² (max. 10 kW/cm ²) to achieve a significant measurement signal.
	For small beam diameters (e.g. $r < 6$ mm) and maximum measuring window, the resolution is too low.	Increase the resolution in the dialog window Device control > Single plane > Advanced in the Pixel in x/y section to something like 1 024 x 1 024 pixels.
	The signal enhancement is too low.	Enter the maximum value of 0 dB in the dialog window Device control > Single plane > Settings in the Gain in dB section.

Tab. 10.1: Troubleshooting

11 Maintenance and service

11.1 Maintenance intervals

The operator is responsible for determining the maintenance intervals for the measuring device. PRIMES recommends a maintenance interval of 12 months for inspection and validation. If the device is used only sporadically, the maintenance interval can also be extended up to 24 months. Please note that the safety and warning functions of the device must be checked regularly.

11.2 Cleaning the device surfaces

1. Close all device openings.
2. First clean the device surfaces with cleaned, oil-free compressed air.
3. For further cleaning, use a mixture of distilled water and isopropanol in a ratio of approx. 5:1. Use lint-free cleaning cloths that do not cause scratches. This can be e.g. microfiber cloths or paper towels from the cosmetics sector.
4. If these steps are not sufficient, please contact PRIMES or your PRIMES distributor.

12 Measures for the product disposal

PRIMES gives you the opportunity to return your PRIMES measuring device for free disposal within the scope of the Waste of Electrical and Electronic Equipment (WEEE Directive). This service does not include shipping costs. You can send PRIMES measuring devices to be disposed of within the EU to our address:

PRIMES GmbH
Max-Planck-Str. 2
64319 Pfungstadt
Germany

If you are located outside the EU, please contact your local PRIMES distributor to discuss the disposal procedure for your PRIMES measuring device.

PRIMES is a registered manufacturer in the German "Used Appliances Register" stiftung elektro-altgeräte register (stiftung ear). Our number is: WEEE-reg.-no. DE65549202.

13 Declaration of conformity

Original EG Declaration of Conformity

The manufacturer: PRIMES GmbH, Max-Planck-Straße 2, 64319 Pfungstadt, Germany,
hereby declares that the device with the designation:

BeamMonitor (BM)

Types: BM 60; BM 100; BM+ 60; BM+ 100S; BM-HQ

is in conformity with the following relevant EC Directives:

- Machinery Directive 2006/42/EC
- EMC Directive EMC 2014/30/EU
- Low voltage Directive 2014/35/EU
- Directive 2011/65/EC on the restriction of the use of certain hazardous substances (RoHS) in electrical and electronic equipment
- Directive 2014/32/EC on measuring instruments

Authorized for the documentation:

PRIMES GmbH, Max-Planck-Straße 2, 64319 Pfungstadt, Germany

The manufacturer obligates himself to provide the national authority in charge with technical documents in response to a duly substantiated request within an adequate period of time.

Pfungstadt, July 27, 2021



Dr. Reinhard Kramer, CEO

14 Technical data

Measurement parameters	BM+ 60	BM+ 100S
Power range	50 – 25 000 W	
Wavelength range	450 – 1090 nm or 10 600 nm	
Beam diameter	5 – 42 mm (NIR) 10 – 42 mm (CO ₂)	10 – 70 mm
Min. power density (CO ₂ devices only)	0.1 kW/cm ² ¹⁾	0.2 kW/cm ² ¹⁾
¹⁾ Lower power densities on request		
Max. power density	10 kW/cm ² ²⁾	
²⁾ Higher power densities on request		
Max. beam divergence	100 mrad	
Irradiation time	2 s – infinite	
A/D conversion	16 bit	
Nominal measuring frequency	Linescan 25 Hz	Linescan 30 Hz
Determined parameters		
Beam position	Yes	
Beam dimensions x, y	Yes	
Power density distribution	2D, 3D	
Linescan	Yes	
Measurement duration per plane depending on measurement parameters (such as resolution, measurement window position)	5 – 40 s	
Device parameters		
Working range x-y	60 x 60 mm	100 x 100 mm
Measurement window sizes	0.1 x 0.1 – 60 x 60 mm	0.1 x 0.1 – 100 x 100 mm
Resolution	32 x 32 – 1024 x 1024 Pixel	
Rotation speed of the measuring tip	1 562 rpm	
Accuracy (beam diameter)	± 5 %	
Reproducibility (beam diameter)	± 3 %	
Supply data		
Power supply	24 V DC ± 5 %, max. 1.8 A	
Communication		
Interfaces	RS485 / Ethernet	
Dimensions and weight		
Dimensions (LxWxH)	316 x 212 x 83 mm	436 x 292 x 83 mm
Weight (approx.)	9 kg	10 kg

Environmental conditions	BM+ 60	BM+ 100S
Operating temperature range	10 – 40 °C	
Storage temperature range	5 – 50 °C	
Reference temperature	22 °C	
Permissible relative humidity (non-condensing)	10 – 80 %	

15 Dimensions

15.1 BeamMonitor BM+ 60

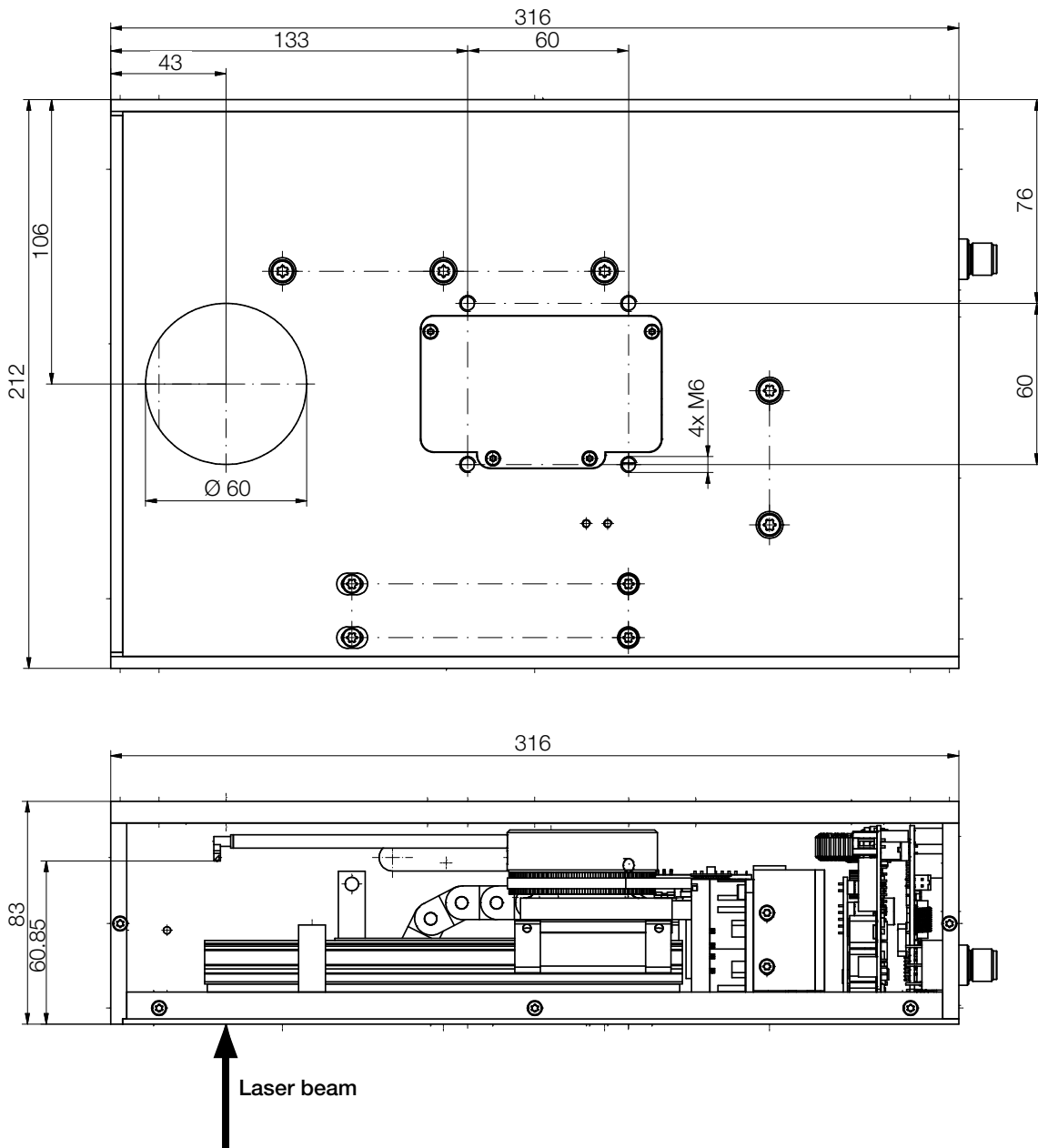

15.2 BeamMonitor BM+ 100S

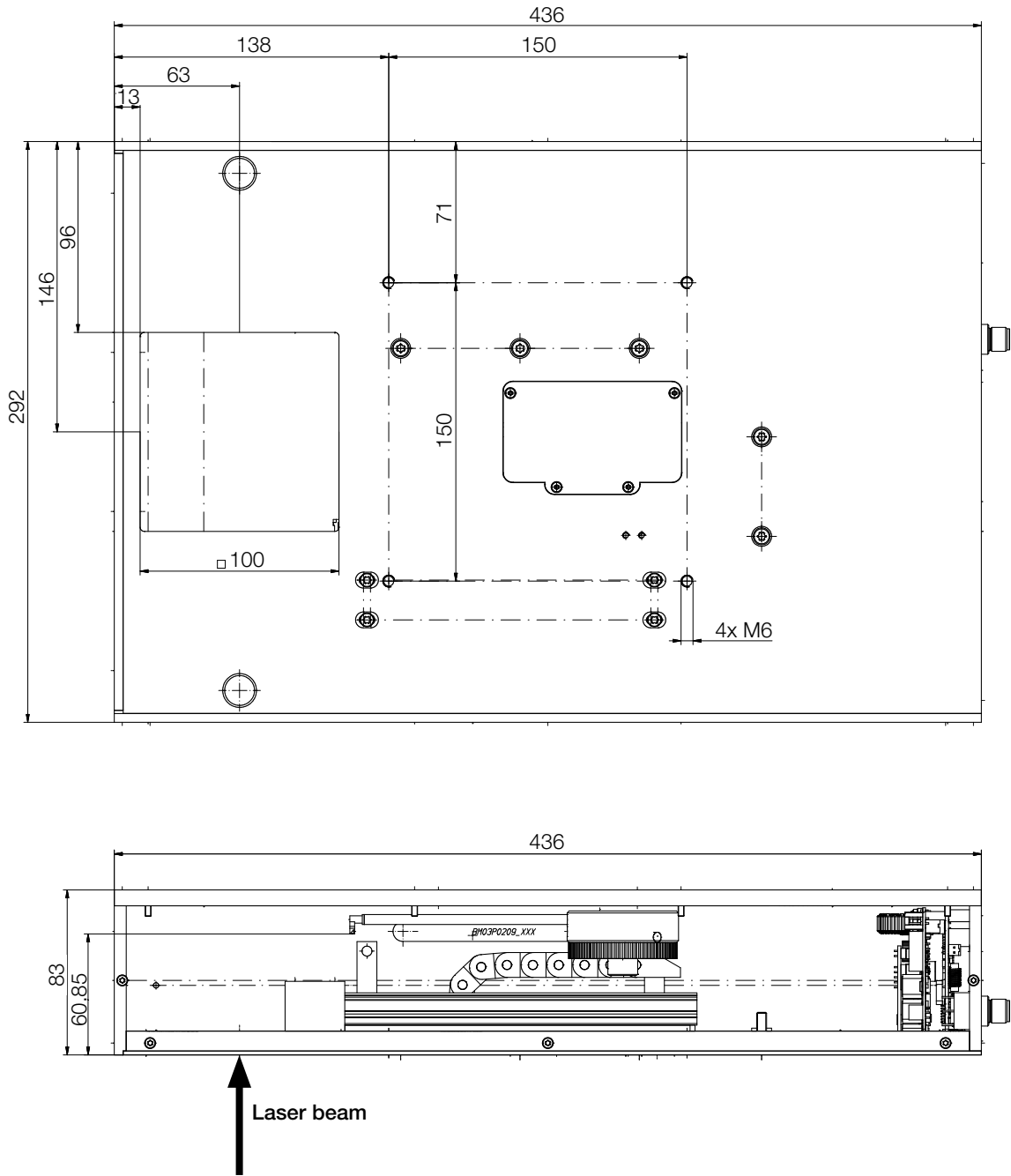

16 Appendix

16.1 GNU GPL license notice

The software of this product contains software code that is licensed subject to the GNU General Public License (GPL) Version 2 or later. The license terms of the GNU GPL Version 2 or later are available on the following websites:

- <https://www.gnu.org/licenses/old-licenses/gpl-2.0.en.html>
- <https://www.gnu.org/licenses/licenses.en.html>

16.2 Variety of detectors

Different detectors are used, depending on the application (see Tab. 16.1 on page 64).

Detector type	Laser	Type of sensor	Amplification	Wavelength range in μm
DBC+	CO ₂	Pyroelectric detector	1	9 – 12
DBY-PS+	NIR / VIS	Photodiode	Automatic adjustment of the sensitivity	0.4 – 1.1
DBIG-PS+	NIR	InGaAs	Automatic adjustment of the sensitivity x	0.8 – 2.1

Tab. 16.1: Variety of detectors

16.3 Replace the detector

Generally, the BeamMonitor BM+ is equipped with a DBIG-PS+ or DBC+ detector, depending on the wavelength. Detectors with different sensitivity or different time behavior can be used for special applications (see Tab. 16.1 on page 64).

16.3.1 Remove cover

1. Turn off the power supply.
2. Unscrew four Torx screws T8 from the cover.
3. Lift the cover to remove it.

The detector is located under the cover.

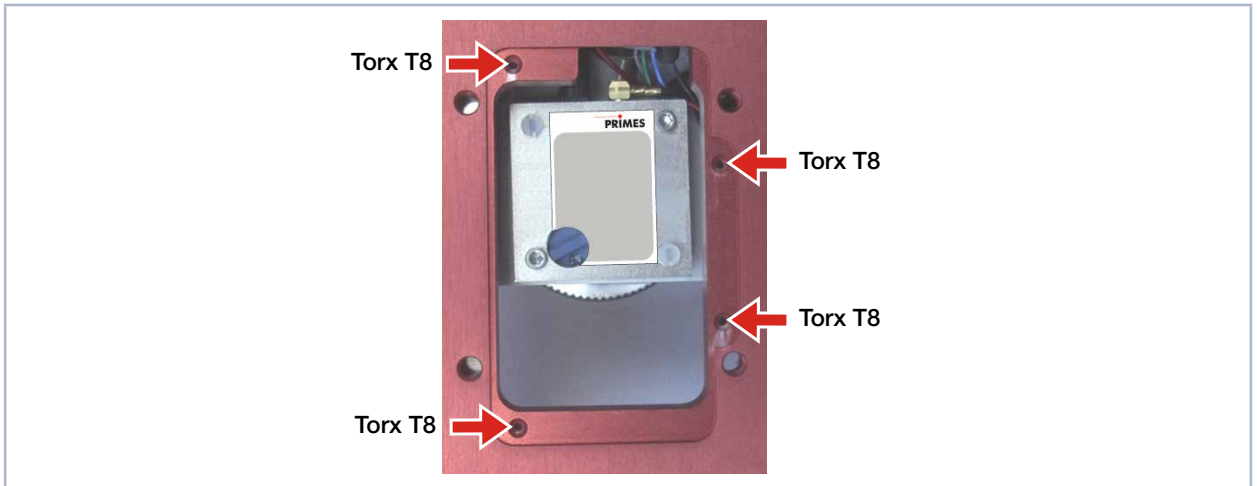

Fig. 16.1: Opened cover of BeamMonitor BM+ with detector

16.3.2 Disassemble the detector

NOTICE

Damage of the detector

Touching the sensor surface will damage the detector. This can negatively affect the measuring results.

- ▶ Do not touch the detector with your fingers on the sensor surface.
- ▶ Don't set the detector on the sensor surface.

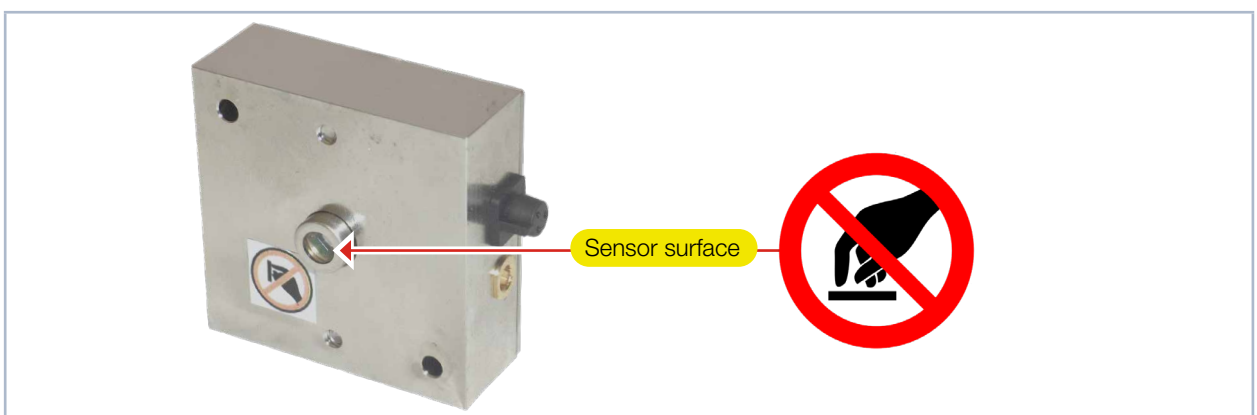

Fig. 16.2: Sensor surface on the detector

1. Remove the plastic screws (D) from the detector (see Fig. 16.3 on page 66).

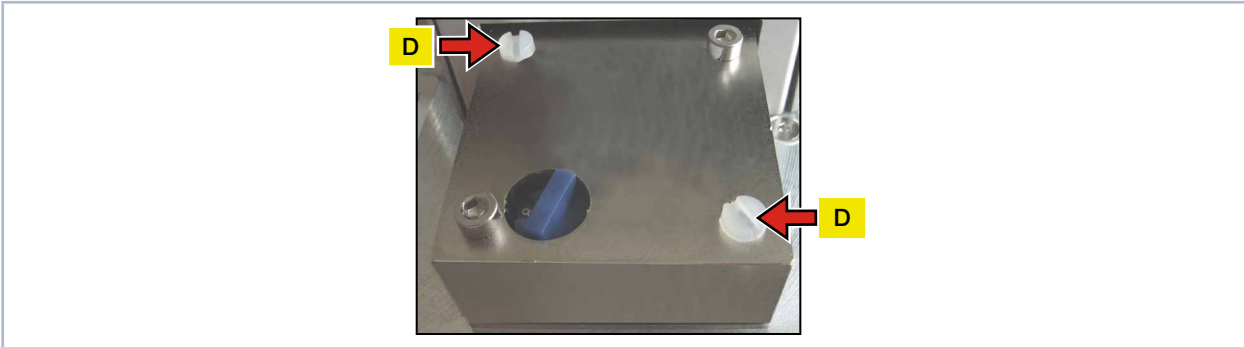

Fig. 16.3: Remove the plastic screws from the detector

2. Carefully remove the detector from the position.
Please do not pull the cables.
3. First loosen the golden angle plug (A), then the black plug (B) (see Fig. 16.4 on page 66).

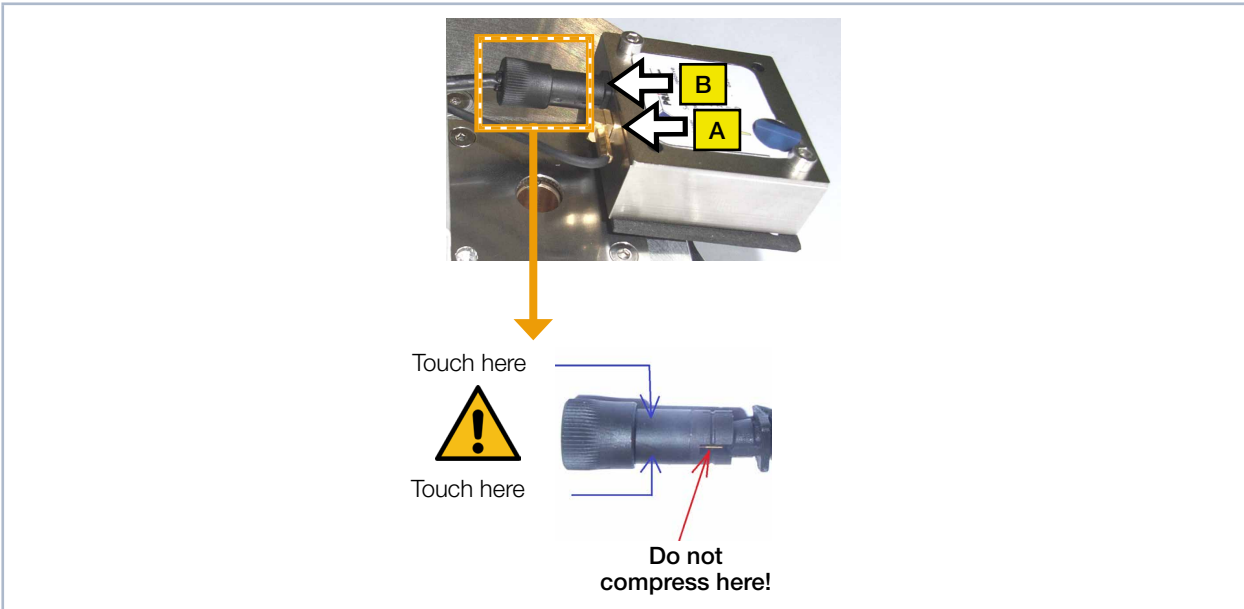

Fig. 16.4: Releasing the plugs from the detector

16.3.3 Assemble the detector



Only use isolating plastic screws to fasten the detector to prevent any electric noise signals from being interspersed. Do not forget the foam rubber spacer during installation, otherwise the rotational disc could be mechanically blocked by the screws. The foam rubber spacer also ensures mechanical decoupling of the detector.

1. Place the foam rubber spacer (C) on the mounting surface of the detector (see Fig. 16.5 on page 67).
2. Connect the cables.

NOTICE

Blocking the rotational disc

If the screws are tightened too firmly, they might block the rotational disc!

- ▶ Only tighten the screws hand-tight. The foam rubber spacer must only be compressed to no more than half its original thickness.

3. Fasten the detector with the two plastic screws (D).

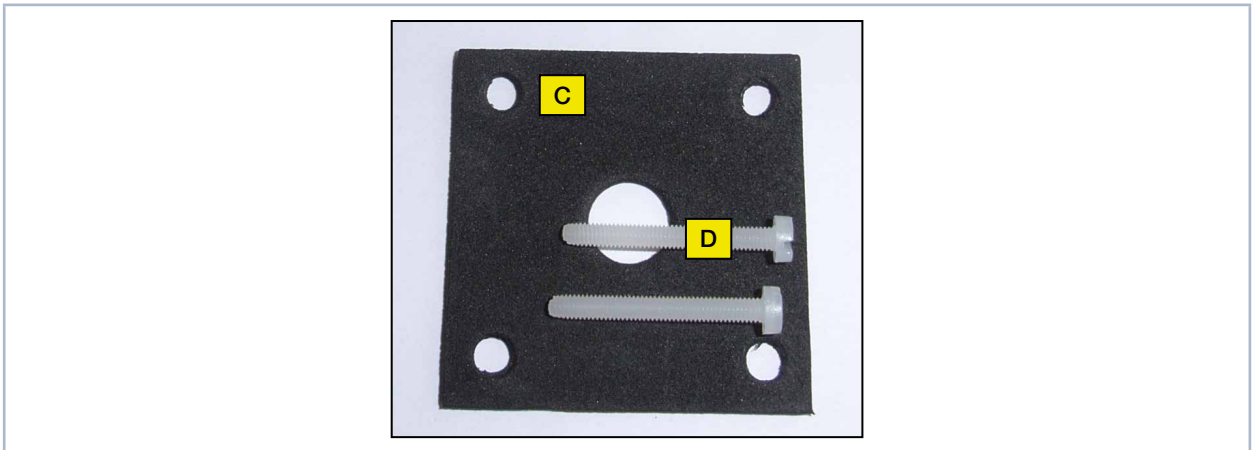

Fig. 16.5: Assembling a new detector

16.3.4 Replace cover

1. Place the cover on the casing (see Fig. 16.1 on page 65).
2. Screw the cover on tight with the four Torx screws T8.
3. Check that the cover is securely seated.
The cover must lay flush with the casing.

